



3-IN-1 SOIL CONDITIONER MODEL SC



**SAFETY INSTRUCTIONS; OPERATING INSTRUCTIONS;
PARTS BREAKDOWNS; ASSEMBLY; MAINTENANCE**

MANUFACTURER'S LIMITED WARRANTY

Manufacturer warrants to original Purchaser that its product is free from major defects in material under normal use and service for a period of 180 days from the date the product is shown to have been placed into operation by original distributor customers or for one year from date of shipment from Manufacturer's plant, whichever shall first occur.

Manufacturer's obligation under this warranty is expressly limited to the repair or replacement, at its option, of the parts which are returned F.O.B. Manufacturer's factory, Yakima, WA, and which are determined by Manufacturer to be defective. Provided further that such parts shall be returned within thirty (30) days from date of failure to Manufacturer through the dealer or distributor from whom the purchase was made. Transportation charges prepaid by customer. Manufacturer assumes no responsibility for outside labor.

THIS IS THE SOLE AND ONLY WARRANTY OF MANUFACTURER AND NO OTHER WARRANTY IS APPLICABLE, EITHER EXPRESSED OR IMPLIED, IN FACT OR BY LAW, INCLUDING ANY WARRANTY AS TO MERCHANTABILITY OR FITNESS FOR A PARTICULAR USE OR PURPOSE.

This warranty shall not be interpreted to render us liable for injury or damages of any kind or nature, direct, consequential, or contingent, to person or property. This warranty does not extend to loss of crops, loss because of delay in harvesting or any expense or loss incurred for labor, supplies, substitute machinery, rental or any other reason.

The sole and only remedy in regard to any defective products shall be the repair or replacement thereof herein provided, and Manufacturer shall not be liable for any consequential, special, incidental, or punitive damages resulting from or caused by any such defects.

Manufacturer reserves the right to make improvements in design or changes in specifications at any time, without incurring any obligations to owners of units previously sold.

No one is authorized to alter, modify, or enlarge this warranty nor the exclusions, limitations, and reservation.

The price of goods sold is determined using this warranty as a cost factor.

**WARRANTY VOID IF NOT REGISTERED
WITHIN 30 DAYS OF PURCHASE DATE**

TABLE OF CONTENTS

SECTION PAGE	DESCRIPTION	
1	Introduction	1
2	Safety	2
2.1	General Safety	3
2.2	Equipment Safety Guidelines	4
2.3	Safety Training	5
2.4	Safety Signs	5
2.5	Preparation	6
2.6	Operating Safety	7
2.7	Transport Safety	8
2.8	Storage Safety	8
2.9	Maintenance Safety	8
2.10	Sign-Off Form	9
3	Safety Sign Locations	10
4	Operation	11
4.1	To the New Operator or Owner	11
4.2	Machine Components	12
4.3	Machine Break-In	12
4.4	Pre-Operation Checklist	12
4.5	Field Operation	13
4.6	Transporting	18
4.7	Storage	18
5	Service and Maintenance	19
5.1	Service	19
5.1.1	Fluid and Lubricants	19
5.1.2	Greasing	19
5.1.3	Servicing Intervals	20
5.1.4	Service Record	20
6	Trouble Shooting	21
7	Assembly	22
8	Specifications	27
8.1	Mechanical	27
8.2	Bolt Torque	28
9	Index	29

SERIAL NUMBER LOCATION

Always give your dealer the serial number of your 3 in 1 Soil Conditioner when ordering parts or requesting service or other information.

The serial number plate is located where indicated. Please mark the number in the space provided for easy reference.

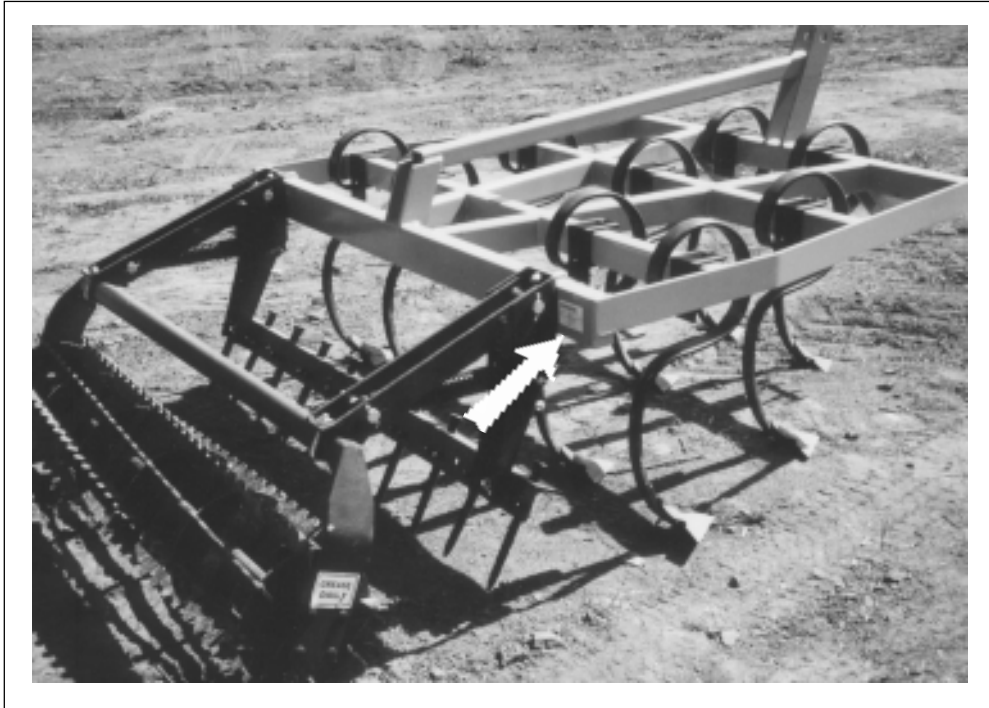

Model Number _____

Serial Number _____

1 INTRODUCTION

Congratulations on your choice of a 3 In 1 Soil Conditioner to complement your cultivation work. This equipment has been designed and manufactured to meet the needs of a discriminating buyer for the efficient cultivating and conditioning soil.

Safe, efficient and trouble free operation of your Soil Conditioner requires that you and anyone else who will be operating or maintaining the machine, read and understand the Safety, Operation, Maintenance and Trouble Shooting information contained within the Operator's Manual.



This manual covers the 3 In 1 Soil Conditioner Models RSC4, RSC5, RSC55, RSC6, RSC7, RSC8, RSC10, RSC12 and RSC15. Differences are explained where appropriate. Use the Table of Contents or Index as a guide to locate required information.

Keep this manual handy for frequent reference and to pass on to new operators or owners. Call your dealer, distributor or the factory if you need assistance, information or additional copies of the manuals.

OPERATOR ORIENTATION - The directions left, right, front and rear, as mentioned throughout this manual, are as seen from the driver's seat and facing in the direction of travel.

2 SAFETY

SAFETY ALERT SYMBOL

This Safety Alert symbol means **ATTENTION! BECOME ALERT! YOUR SAFETY IS INVOLVED!**

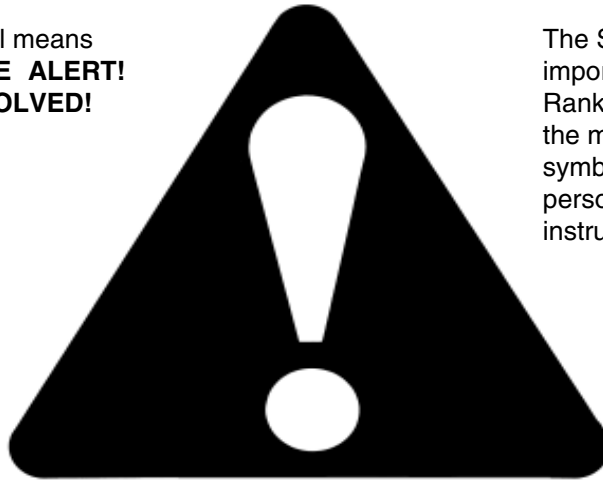

The Safety Alert symbol identifies important safety messages on the Rankin 3 In 1 Soil Conditioner and in the manual. When you see this symbol, be alert to the possibility of personal injury or death. Follow the instructions in the safety message.

Why is SAFETY important to you?

3 Big Reasons

Accidents Disable and Kill
Accidents Cost
Accidents Can Be Avoided

SIGNAL WORDS:

Note the use of the signal words **DANGER**, **WARNING** and **CAUTION** with the safety messages. The appropriate signal word for each message has been selected using the following guide-lines:

SI NO LEE INGLES, PIDA AYUDA A AIGUIEN QUE SI LO LEA PARA QUE LE TRADUZCA LAS MIDIDAS DE SEGURIDAD.

DANGER - Indicates an imminently hazardous situation that, if not avoided, will result in death or serious injury. This signal word is to be limited to the most extreme situations typically for machine components which, for functional purposes, cannot be guarded.

WARNING - Indicates a potentially hazardous situation that, if not avoided, could result in death or serious injury, and includes hazards that are exposed when guards are removed. It may also be used to alert against unsafe practices.

CAUTION - Indicates a potentially hazardous situation that, if not avoided, may result in minor or moderate injury. It may also be used to alert against unsafe practices.

If you have any questions not answered in this manual or require additional copies or the manual is damaged, please contact your dealer.

SAFETY

YOU are responsible for the **SAFE** operation and maintenance of your 3 In 1 Soil Conditioner. **YOU** must ensure that you and anyone else who is going to operate, maintain or work around the Soil Conditioner be familiar with the operating and maintenance procedures and related **SAFETY** information contained in this manual. This manual will take you step-by-step through your working day and alerts you to all good safety practices that should be adhered to while operating the Conditioner.

Remember, **YOU** are the key to safety. Good safety practices not only protect you but also the people around you. Make these practices a working part of your safety program. Be certain that **EVERYONE** operating this equipment is familiar with the recommended operating and maintenance procedures and follows all the safety precautions. Most accidents can be prevented. Do not risk injury or death by ignoring good safety practices.

- Conditioner owners must give operating instructions to operators or employees before allowing them to operate the machine, and at least annually thereafter per OSHA (Occupational Safety and Health Administration) regulation 1928.57.
- The most important safety feature on this equipment is a **SAFE** operator. It is the operator's responsibility to read and understand **ALL** Safety and Operating instructions in the manual and to follow these. Most accidents can be avoided.
- A person who has not read and understood all operating and safety instructions is not qualified to operate the machine. An untrained operator exposes himself and bystanders to possible serious injury or death.
- Do not modify the equipment in any way. Unauthorized modification may impair the function and/or safety and could affect the life of the equipment.
- Think **SAFETY!** Work **SAFELY!**

2.1 GENERAL SAFETY

1. Read and understand the Operator's Manual and all safety signs before operating, maintaining, adjusting or unplugging the Conditioner.



2. Have a first-aid kit available for use should the need arise and know how to use it.

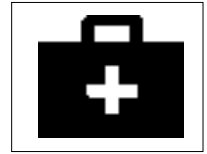

3. Have a fire extinguisher available for use should the need arise and know how to use it.

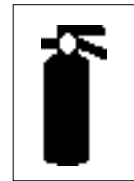

4. Wear appropriate protective gear. This list includes but is not limited to:

- A hard hat
- Protective shoes with slip resistant soles
- Protective goggles, glasses or face shield
- Heavy gloves
- Protective clothing



5. Install and secure all guards before starting.
6. Do not allow riders.
7. Wear suitable ear protection for prolonged exposure to excessive noise.



8. Place all controls in neutral, stop tractor engine, set park brake, remove ignition key and wait for all moving parts to stop before servicing, adjusting, repairing or unplugging.
9. Clear the area of people, especially small children, before starting.
10. Review safety related items annually with all personnel who will operating or maintaining the Conditioner.

2.2 EQUIPMENT SAFETY GUIDELINES

1. Safety of the operator and bystanders is one of the main concerns in designing and developing a machine. However, every year many accidents occur which could have been avoided by a few seconds of thought and a more careful approach to handling equipment. You, the operator, can avoid many accidents by observing the following precautions in this section. To avoid personal injury or death, study the following precautions and insist those working with you, or for you, follow them.
2. In order to provide a better view, certain photographs or illustrations in this manual may show an assembly with a safety shield removed. However, equipment should never be operated in this condition. Keep all shields in place. If shield removal becomes necessary for repairs, replace the shield prior to use.
3. Replace any safety sign or instruction sign that is not readable or is missing. Location of such safety signs is indicated in this manual.
4. Never use alcoholic beverages or drugs which can hinder alertness or coordination while operating this equipment. Consult your doctor about operating this machine while taking prescription medications.
5. **Under no circumstances should young children be allowed to work with this equipment. Do not allow persons to operate or assemble this unit until they have read this manual and have developed a thorough understanding of the safety precautions and of how it works.** Review the safety instructions with all users annually.
6. This equipment is dangerous to children and persons unfamiliar with its operation. The operator should be a responsible, properly trained and physically able person familiar with farm machinery and trained in this equipment's operations. If the elderly are assisting with farm work, their physical limitations need to be recognized and accommodated.
7. Use a tractor equipped with a Roll Over Protective Structure (ROPS) and a seat belt.
8. Never exceed the limits of a piece of machinery. If its ability to do a job, or to do so safely, is in question - **DON'T TRY IT.**
9. Do not modify the equipment in any way. Unauthorized modification result in serious injury or death and may impair the function and life of the equipment.
10. In addition to the design and configuration of this implement, including Safety Signs and Safety Equipment, hazard control and accident prevention are dependent upon the awareness, concern, prudence, and proper training of personnel involved in the operation, transport, maintenance, and storage of the machine. Refer also to Safety Messages and operation instruction in each of the appropriate sections of the Tractor and machine Manuals. Pay close attention to the Safety Signs affixed to the Tractor and the machine.

2.3 SAFETY TRAINING

1. Safety is a primary concern in the design and manufacture of our products. Unfortunately, our efforts to provide safe equipment can be wiped out by a single careless act of an operator or bystander.
2. In addition to the design and configuration of equipment, hazard control and accident prevention are dependent upon the awareness, concern, prudence and proper training of personnel involved in the operation, transport, maintenance and storage of this equipment.
3. It has been said, "The best safety feature is an informed, careful operator." We ask you to be that kind of an operator. It is the operator's responsibility to read and understand ALL Safety and Operating instructions in the manual and to follow these. Accidents can be avoided.
4. Working with unfamiliar equipment can lead to careless injuries. Read this manual, and the manual for your tractor, before assembly or operating, to acquaint yourself with the machines. If this machine is used by any person other than yourself, or is loaned or rented, it is the machine owner's responsibility to make certain that the operator, prior to operating:
 - a. Reads and understands the operator's manuals.
 - b. Is instructed in safe and proper use.
5. Know your controls and how to stop tractor, engine, and machine quickly in an emergency. Read this manual and the one provided with your tractor.
6. Train all new personnel and review instructions frequently with existing workers. Be certain only a properly trained and physically able person will operate the machinery. A person who has not read and understood all operating and safety instructions is not qualified to operate the machine. An untrained operator exposes himself and bystanders to possible serious injury or death. If the elderly are assisting with farm work, their physical limitations need to be recognized and accommodated.

2.4 SAFETY SIGNS

1. Keep safety signs clean and legible at all times.
2. Replace safety signs that are missing or have become illegible.
3. Replaced parts that displayed a safety sign should also display the current sign.
4. Safety signs are available from your authorized Distributor or Dealer Parts Department or the factory.

How to Install Safety Signs:

- Be sure that the installation area is clean and dry.
- Be sure temperature is above 50°F (10°C).
- Determine exact position before you remove the backing paper. (See Section 3).
- Remove the smallest portion of the split backing paper.
- Align the sign over the specified area and carefully press the small portion with the exposed sticky backing in place.
- Slowly peel back the remaining paper and carefully smooth the remaining portion of the sign in place.
- Small air pockets can be pierced with a pin and smoothed out using the piece of sign backing paper.

2.5 PREPARATION

1. Never operate the tractor and machine until you have read and completely understand this manual, the Tractor Operator's Manual, and each of the Safety Messages found on the safety signs on the tractor and machine.

2. Personal protection equipment including hard hat, safety glasses, safety shoes, and gloves are recommended during assembly, installation, operation, adjustment, maintaining, repairing, removal, or moving the implement. Do not allow long hair, loose fitting clothing or jewellery to be around equipment.



3. **PROLONGED EXPOSURE TO LOUD NOISE MAY CAUSE PERMANENT HEARING LOSS!**

Tractors with or without equipment attached can often be noisy enough to cause permanent, partial hearing loss. We recommend that you wear hearing protection on a full-time basis if the noise in the Operator's position exceeds 80db. Noise over 85db on a long-term basis can cause severe hearing loss. Noise over 90db adjacent to the Operator over a long-term basis may cause permanent, total hearing loss. **NOTE:** Hearing loss from loud noise (from tractors, chain saws, radios, and other such sources close to the ear) is cumulative over a lifetime without hope of natural recovery.



4. Operate the machine only with a tractor equipped with an approved Roll-Over-Protective Structure (ROPS). Always wear your seat belt. Serious injury or even death could result from falling off the tractor ---particularly during a turnover when the operator could be pinned under the ROPS or the tractor.
5. Clear working area of stones, branches or hidden obstacles that might be hooked or snagged, causing injury or damage.
6. Operate only in daylight or good artificial light.
7. Be sure machine is properly mounted, adjusted and in good operating condition.
8. Ensure that all safety shielding and safety signs are properly installed and in good condition.



2.6 OPERATING SAFETY

1. Please remember it is important that you read and heed the safety signs on the 3 In 1 Soil Conditioner. Clean or replace all safety signs if they cannot be clearly read and understood. They are there for your safety, as well as the safety of others. The safe use of this machine is strictly up to you, the operator.
2. All things with moving parts are potentially hazardous. There is no substitute for a cautious, safe-minded operator who recognizes potential hazards and follows reasonable safety practices. The manufacturer has designed this 3 In 1 Soil Conditioner to be used with all its safety equipment properly attached, to minimize the chance of accidents. Study this manual to make sure you have all safety equipment attached.
3. If a safety shield or guard is removed for any reason, it must be replaced before the machine is again operated.
4. When the use of hand tools is required to perform any part of assembly, installation, adjustment, maintaining, repairing, removal, or moving, be sure the tools used are designed and recommended by the tool manufacturer for that specific task.
5. Personal protection equipment including hard hat, safety glasses, safety shoes, and gloves are recommended during assembly, installation, operation, adjustment, maintaining, repairing, removal, or moving. Do not allow long hair, loose fitting clothing, or jewellery to be around moving parts.
6. Always use two people to handle heavy, unwieldy components during assembly, installation, removal or moving.
7. Never place any part of your body where it would be in danger if movement should occur during assembly, installation, operation, maintaining, repairing, removal or moving.
8. Never place yourself between the tractor and machine while implement is in operation.
9. Do not walk or work under a raised machine or attachment unless it is securely blocked or held in position. Do not depend on the tractor hydraulic system to hold the machine or attachment in place.
10. A heavy load can cause instability of the tractor. Use extreme care during travel. Slow down on turns and watch out for bumps. The tractor may need front counterweights to counterbalance the weight of the machine.
11. Never use alcoholic beverages or drugs which can hinder alertness or coordination while operating this equipment. Consult your doctor about operating this machine while taking prescription medications.
12. Do not allow riders on the machine or tractor at any time. There is no safe place for any riders.
13. Before you operate the machine, check over all pins, bolts, and connections to be sure all are securely in place. Replace any damaged or worn parts immediately.
14. Do not allow anyone who is not familiar with the safety rules and operation instructions to use this machine.
15. Never allow children to operate or be around this machine.
16. Use stabilizer bars, adjustable sway chains, or sway blocks on the tractor lift arms to keep the machine from swinging side to side. Adjust as tightly as practical for best performance.
17. Clear the work area of objects which might be picked up and snagged or entangled in the machine.
18. Keep hands, feet, hair, jewellery, and clothing away from all moving and/or rotating parts.

2.7 TRANSPORT SAFETY

1. Comply with state and local laws governing highway safety and movement of farm machinery on public roads.
2. The use of flashing amber lights is acceptable in most localities. However, some localities prohibit their use. Local laws should be checked for all highway lighting and marking requirements.
3. At all times, when driving the tractor and equipment on the road or highway under 20 mph (32 kph) use flashing amber warning lights and a slow moving vehicle (SMV) identification emblem. Do not exceed 20 mph (32 kph). Reduce speed on rough roads and surfaces.
4. Plan your route to avoid heavy traffic.
5. Always install transport locks, pins or brackets before transporting.
6. Do not drink and drive.
7. Be a safe and courteous driver. Always yield to oncoming traffic in all situations, including narrow bridges, intersections, etc. Watch for traffic when operating near or crossing roadways.
8. Turn into curves or go up or down hills only at a low speed and at a gradual steering angle. Make certain that at least 20% of the tractor's weight is on the front wheels to maintain safe steering. Slow down on rough or uneven surfaces.
9. Never allow riders on either tractor or machine.

2.8 STORAGE SAFETY

1. Store the unit in an area away from human activity.
2. Do not permit children to play on or around the stored machine.
3. Store the unit in a dry, level area. Support the frame with planks if required.

2.9 MAINTENANCE SAFETY

1. Good maintenance is your responsibility. Poor maintenance is an invitation to trouble.
2. Follow good shop practices.

- Keep service area clean and dry.
- Be sure electrical outlets and tools are properly grounded.
- Use adequate light for the job at hand.



3. Make sure there is plenty of ventilation. Never operate the engine of the towing vehicle in a closed building. The exhaust fumes may cause asphyxiation.
4. Before working on this machine, shut off the engine, set the brakes, and remove the ignition keys.
6. Never work under equipment unless it is blocked securely.
7. Use personal protection devices such as eye, hand and hearing protectors, when performing any service or maintenance work.
8. Where replacement parts are necessary for periodic maintenance and servicing, genuine factory replacement parts must be used to restore your equipment to original specifications. The manufacturer will not be responsible for injuries or damages caused by use of unapproved parts and/or accessories.
9. A fire extinguisher and first aid kit should be kept readily accessible while performing maintenance on this equipment.

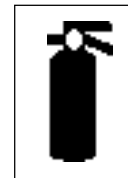

10. Periodically tighten all bolts, nuts and screws and check that all cotter pins are properly installed to ensure unit is in a safe condition.
11. When completing a maintenance or service function, make sure all safety shields and devices are installed before placing unit in service.

3 SAFETY SIGN LOCATIONS

The types of safety signs and locations on the equipment are shown in the illustration below. Good safety requires that you familiarize yourself with the various safety signs, the type of warning and the area, or particular function related to that area, that requires your SAFETY AWARENESS.



A

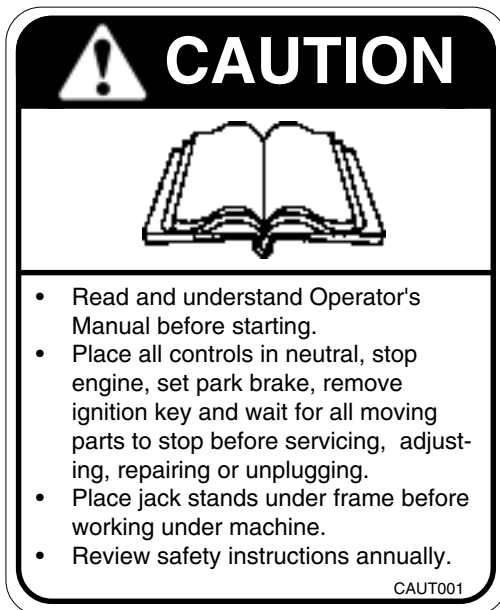

REMEMBER - If safety signs have been damaged, removed, become illegible or parts replaced without signs, new signs must be applied. New signs are available from your authorized dealer.

4 OPERATION



OPERATING SAFETY

1. Read and understand the Operator's Manual and all safety signs before operating, servicing, adjusting, repairing or unplugging.
2. Do not allow riders.
3. Install and secure all guards and shields before starting or operating.
4. Keep hands, feet, hair and clothing away from moving parts.
5. Place all controls in neutral, stop tractor engine, set park brake, remove ignition key and wait for all moving parts to stop before servicing, adjusting, repairing or unplugging.
6. Place all tractor and machine controls in neutral before starting.
7. Never start or operate machine unless sitting on tractor seat.
8. Clear the area of bystanders, especially small children, before starting.
9. Clean reflectors, SMV and lights before transporting.
10. Use hazard flashers on tractor when transporting.
11. Do not put hands or feet under machine while tractor engine is running.
12. Review safety instructions with all operators annually.

4.1 TO THE NEW OPERATOR OR OWNER

3 In 1 Soil Conditioners are designed as a light duty soil conditioner for general cultivation in nurseries, orchards, vineyards and for berry growers. Be familiar with the machine before starting.

It is the responsibility of the owner or operator to read this manual and to train all other operators before they start working with the machine. Follow all safety instructions exactly. Safety is everyone's business. By following recommended procedures, a safe working environment is provided for the operator, bystanders and the area around the worksite. Untrained operators are not qualified to operate the machine.

Many features incorporated into this machine are the result of suggestions made by customers like you. Read this manual carefully to learn how to operate the machine safely and how to set it to provide maximum field efficiency. By following the operating instructions in conjunction with a good maintenance program, your 3 In 1 Soil Conditioner will provide many years of trouble-free service.

4.2 MACHINE COMPONENTS

3 In 1 Soil Conditioners are designed with a S-Tine Cultivator in front for cultivation, a spring-loaded spiketooth bar for leveling and clod breakup and a spring-loaded rear crumbler roller for mulching the soil.

- A Cultivator Frame**
- B 3 Point Hitch Frame**
- C Shovels**
- D Tines**
- E Spiketooth Bar**
- F Crumbler Roller**
- G Spring-Loaded Mount**
- H Gauge Wheels are standard equipment on 10', 12' & 15' models.**

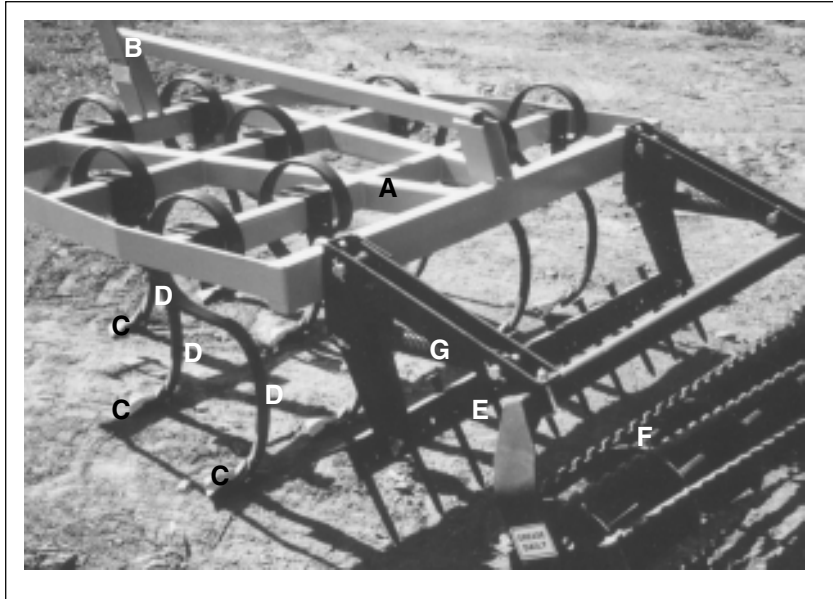

Fig. 1 MACHINE COMPONENTS

4.3 MACHINE BREAK-IN

Although there are no operational restrictions on the Conditioner when used for the first time, it is recommended that the following mechanical items be checked:

A. After Operating For 1 and 5 Hours:

1. Check all nuts, bolts and other fasteners. Tighten to their specified torque level.
2. Check that the tines are in good condition.
3. Then go to the regular service schedule as defined in Section 5.

4.4 PRE-OPERATION CHECKLIST

Efficient and safe operation of the 3 In 1 Soil Conditioner requires that each operator reads and understands the operating procedures and all related safety precautions outlined in this section. A pre-operation checklist is provided for the operator. It is important for both the personal safety and maintaining the good mechanical condition of the Soil Conditioner that this checklist is followed.

Before operating the machine and each time thereafter, the following areas should be checked off:

1. Use only an Agricultural tractor of the recommended horsepower on the machine.
2. Check that the machine is properly attached to the tractor. Be sure retainers are used on the mounting pins.
3. Be sure extra weights are mounted on the front of the tractor if needed.
4. Check the tines/shovels/teeth. Be sure they are not damaged or broken and not badly worn. Repair or replace as required.
5. Check for entangled material. Remove this material.

4.5 FIELD OPERATION



OPERATING SAFETY

1. Read and understand the Operator's Manual and all safety signs before operating, servicing, adjusting, repairing or unplugging.
2. Do not allow riders.
3. Install and secure all guards and shields before starting or operating.
4. Keep hands, feet, hair and clothing away from moving parts.
5. Place all controls in neutral, stop tractor engine, set park brake, remove ignition key and wait for all moving parts to stop before servicing, adjusting, repairing or unplugging.
6. Place all tractor and machine controls in neutral before starting.
7. Never start or operate machine unless sitting on tractor seat.
8. Clear the area of bystanders, especially small children, before starting.
9. Clean reflectors, SMV and lights before transporting.
10. Use hazard flashers on tractor when transporting.
11. Do not put hands or feet under machine while tractor engine is running.
12. Review safety instructions with all operators annually.

3 In 1 Soil Conditioners are designed as a light to moderate tillage tool for cultivating and conditioning soil in a variety of conditions utilizing S-Tine Cultivator shanks, spike tooth bar and a crumbler roller. However the operator has the responsibility of being familiar with all operating and safety procedures and following them.

Each operator should review this section of the manual at the start of the season and as often as required to be familiar with the machine. When using, follow this procedure:

1. Review and follow the Pre-Operation Checklist.
2. Attach the tractor to the machine.
 - a. Move the lift arms and slide the balls over the mounting pins. Install the retainers.
 - b. Attach the top link to the mast. Install the retainer.

IMPORTANT

Do not use on a tractor of more than the recommended horsepower. Larger tractors can overload and bend the frame, tines, teeth or mulcher.

- c. Always engage the anti-sway components on each lift arm to keep the unit from moving from side-to-side during operation.

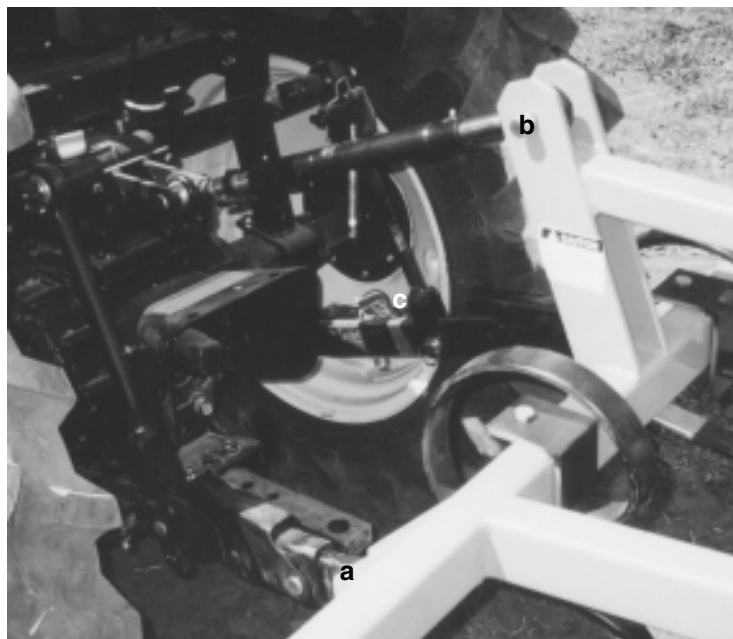

Fig. 2 ATTACHED

3. **Horsepower/3 Point Hitch:**
Each Soil Conditioner model is designed for a tractor of a certain horsepower range and 3 point hitch size as specified in Table 1. Do not exceed the recommended horsepower range to prevent overloading the structural components. Always use the appropriately sized mounting pins when hooking up to a tractor.
4. Before going to the working area review Section 4.6 Transporting.
5. Drive to the working area and stop in a level area.
6. Lower into working position.

TABLE 1 HORSEPOWER VS MODEL

MODEL	SHANKS	HITCH CATEGORY	HORSEPOWER RANGE
RSC4	7	1	14-25
RSC5	9	1	18-32
RSC5-5	10	1	20-35
RSC6	11	1	22-39
RSC7	13	1	26-46
RSC8	15	2	30-53
RSC10	19	2	38-67
RSC12	23	2	46-81
RSC15	29	2	58-102

7. **Set the Machine:**

- a. **Level the Frame:**
Use the screw jack on the right lift arm to level the frame from side-to-side.
- b. **Frame Angle:**
Use the turnbuckle on the top link to set the frame angle. Normally the frame should be set parallel to the ground.
- c. **3 Point Hitch:**
Set the 3 point hitch on the tractor into the "float" mode to allow the tines/teeth/mulcher to follow the contour of the ground. This will maintain a constant tine pressure at all times.
- d. **Spiketooth Harrow Bar:**
The Spiketooth Harrow Bar is located behind the cultivator section and mounted on a spring-loaded frame. The best results are obtained when the teeth are set at approximately the same depth as the cultivator shovels and the teeth can level the loosened soil and break-up the clods. Move the Harrow Bar up and down on its mounting bracket to set the depth.
- e. **Crumbler Roller:**
The design of the machine sets the position of the Roller behind the machine. It will turn/roll and break-up any clods or lumps as it goes across the field. Do not allow mud or trash to build up and reduce the effectiveness of the roller. Move the spring-loaded mounting bracket up and down on the cultivator frame to adjust the roller position,



Fig. 3 LEVELING

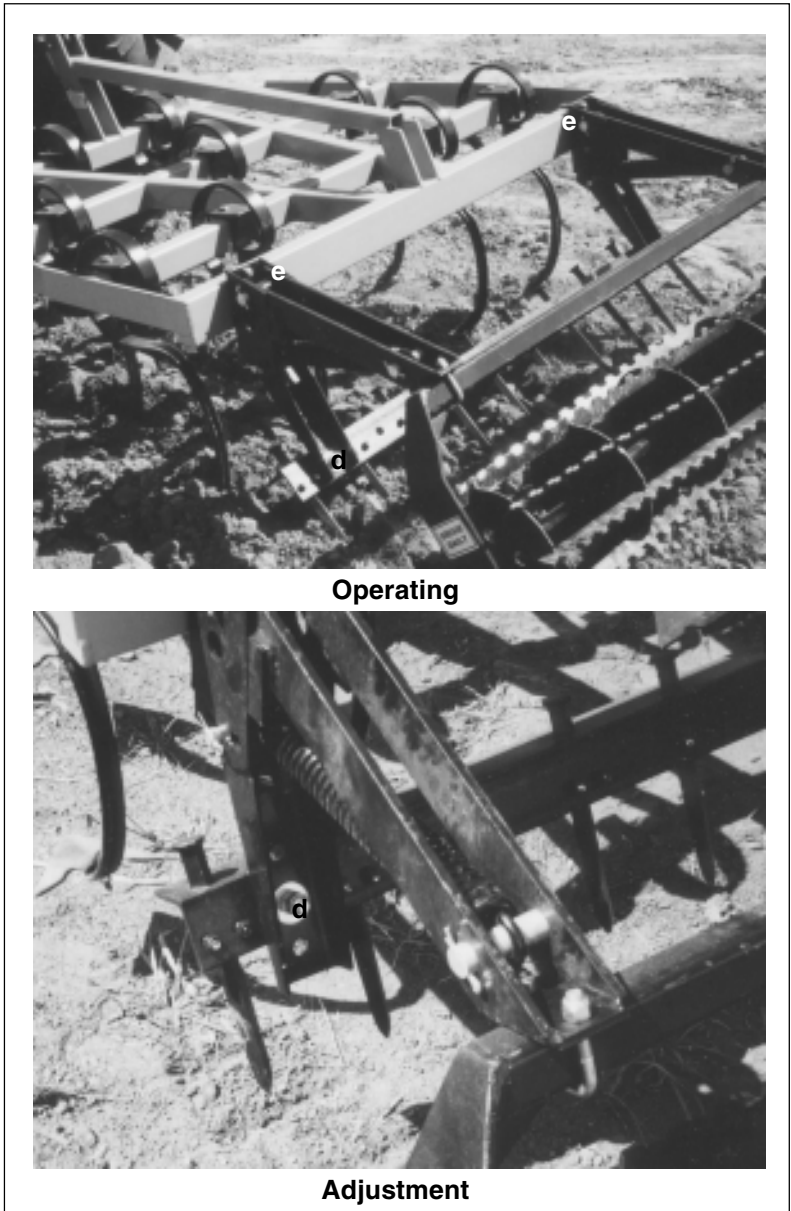

Fig. 4 HARROW BAR/ROLLER

8. Lower the hitch and drive over the area to be worked.
9. **Ground Speed:**
Although the Soil Conditioner can be operated at any speed, it is recommended that moderate speeds be used. High speeds can lead to skipping by the tines and an uneven job. 3 to 5 mph will give the best results. The operator will have to experiment a little to determine the best speed. Use the type of job being done as a guide.



Fig. 5 WORKING

10. **Depth:**
The Soil Conditioner can be set at almost any depth to work up the soil. In most applications, 4 to 6 inches provides good results. Load the tractor engine to 80% load factor. Tractor horsepower in many cases will determine operating speed and depth.



Fig. 6 DEPTH

11. Operating Hints:

- a. Set the top link so the frame is level at operating depth. This will insure that the cultivator, harrow and mulcher parts of the machine function equally.
- b. Do not work when the soil is wet and sticky. It will ball up in front of the harrows and stick to the mulcher. Let it dry before starting to work.
- c. Do not exceed the recommended horsepower for the tractor. Too much power can overload the structural components and lead to failures.
- d. Set the 3 point hitch in float to allow it to follow the ground contour.
- e. Gauge wheels are standard on the RSC10, RSC12 and RSC15 models.

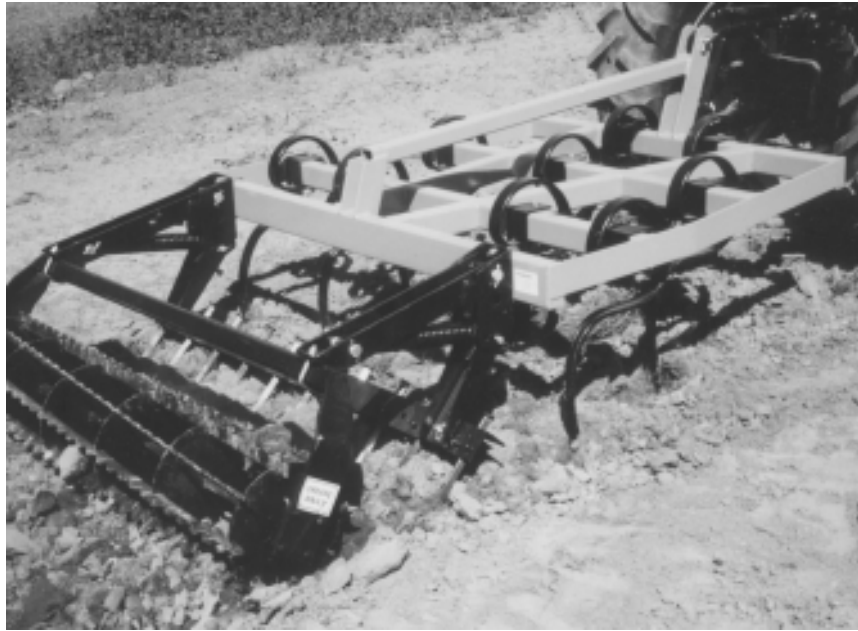

Fig. 7 WORKING



**Fig. 8 GAUGE WHEELS
(TYPICAL MOUNTING POSITION)**

4.6 TRANSPORTING



TRANSPORT SAFETY

1. Make sure you are in compliance with all local regulations regarding transporting equipment on public roads and highways.
2. Make sure the SMV (Slow Moving Vehicle) emblem and all the lights and reflectors that are required by the local highway and transport authorities are in place, are clean and can be seen clearly by all overtaking and oncoming traffic.
3. Do not allow anyone to ride on the Soil Conditioner or tractor during transport.
4. Do not exceed 20 mph (32 kph). Reduce speed on rough roads and surfaces.
5. Use retainers on the mounting pins when attaching.
6. Always use hazard flashers on the tractor when transporting unless prohibited by law.

When transporting the machine, review and follow these instructions:

1. Be sure all bystanders are clear of the machine.
2. Be sure that the machine is securely attached to the tractor and all retainer pins are installed.
3. Be sure you have installed extra weights on the front of the tractor if required.
4. Clean the SMV emblem, lights and reflectors and be sure they are working.
5. Be sure you are in compliance with all applicable lighting and marking regulations when transporting. Check with your local authorities.
6. Be sure your machine can clearly be seen by overtaking and oncoming traffic.
7. Keep to the right and yield the right-of-way to allow faster traffic to pass. Drive on the road shoulder if permitted by law.
8. Do not allow riders.
9. Always use hazard flashers on the tractor when transporting unless prohibited by law.

4.7 STORAGE



STORAGE SAFETY

1. Store the unit in an area away from human activity.
2. Do not permit children to play on or around the stored machine.
3. Store the unit in a dry, level area. Support the frame with planks if required.

After the season's use, the machine should be thoroughly inspected and prepared for storage. Repair or replace any worn or damaged components to prevent any unnecessary down time at the start of next season. To insure a long, trouble free life, this procedure should be followed when preparing the unit for storage:

1. Clear the area of bystanders, especially small children.
2. Thoroughly wash the machine using a pressure washer to remove all dirt, mud, debris and residue.
3. Inspect the tines, shovels, teeth and mulcher and pivot for damage or entangled material. Repair or replace damaged parts. Remove all entangled material.
4. Touch up all paint nicks and scratches to prevent rusting.
5. Move to storage area.
6. Select an area that is dry, level and free of debris.
7. Unhook from tractor.
8. If the machine cannot be placed inside, cover with a waterproof tarpaulin and tie securely in place.
9. Store the machine in an area away from human activity.
10. Do not allow children to play on or around the stored machine.

5 SERVICE AND MAINTENANCE



MAINTENANCE SAFETY

1. Follow ALL the operating, maintenance and safety information in the manual.
2. Support the machine with blocks or safety stands when working beneath it.
3. Follow good shop practices.
 - Keep service area clean and dry.
 - Be sure electrical outlets and tools are properly grounded.
 - Use adequate light for the job at hand.
3. Make sure there is plenty of ventilation. Never operate the engine of the towing vehicle in a closed building. The exhaust fumes may cause asphyxiation.
4. Use only tools, jacks and hoists of sufficient capacity for the job.
5. Make sure all guards are in place and properly secured when maintenance work is completed.
6. Keep hands, feet, hair and clothing away from moving or rotating parts.
7. Clear the area of bystanders, especially small children, when carrying out any maintenance and repairs or making any adjustments.

5.1 SERVICE

5.1.1 FLUIDS AND LUBRICANTS

1. **Grease:**
Use an SAE multi-purpose high temperature grease with extreme pressure (EP) performance. Also acceptable is an SAE multipurpose lithium base grease.
2. **Storing Lubricants:**
Your machine can operate at top efficiency only if clean lubricants are used. Use clean containers to handle all lubricants. Store them in an area protected from dust, moisture and other contaminants.

5.1.2 GREASING

Use the Maintenance Checklist provided to keep a record of all scheduled maintenance.

1. Use a hand-held grease gun for all greasing.
2. Wipe grease fitting with a clean cloth before greasing to avoid injecting dirt and grit.
3. Replace and repair broken fittings immediately.
4. If fittings will not take grease, remove and clean thoroughly. Also clean lubricant passage. Replace fitting if necessary.

5.1.3 SERVICING INTERVALS

The period recommended is based on normal operating conditions. Severe or unusual conditions may require more frequent servicing.

Daily or 10 Hours

1. Grease the crumbler roller bearings (2 locations).

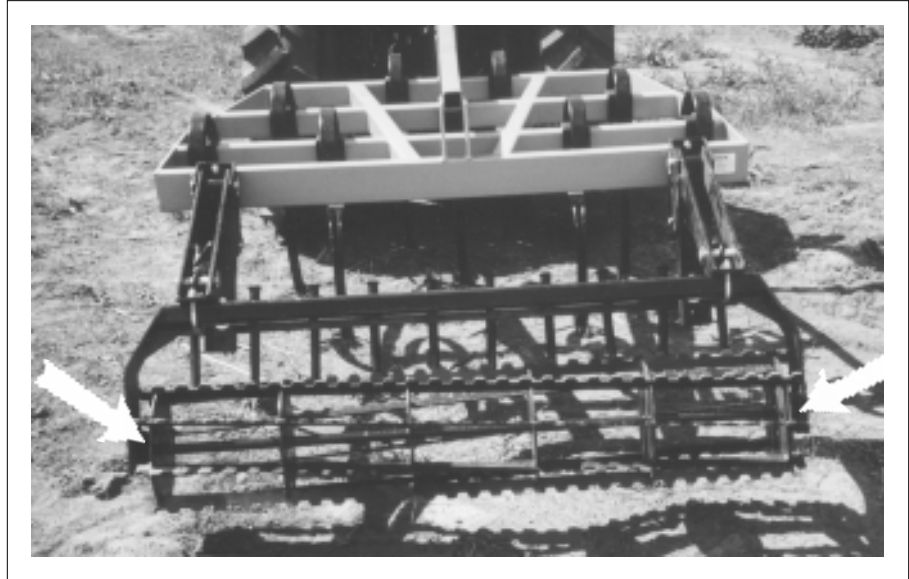

Fig. 9 CRUMBLER ROLLER BEARINGS

Annually

1. Clean machine.

5.1.4 SERVICE RECORD

See Lubrication and Maintenance sections for details of service. Copy this page to continue record.

ACTION CODE: G GREASE CL CLEAN

MAINTENANCE	HOURS																	
	SERVICED BY																	
Daily or 10 Hours																		
G Crumbler Roller Bearings (2)																		
Annually																		
CL Machine																		

6 TROUBLE SHOOTING

Soil Conditioners are designed with S-Tine Cultivator Shanks, Spiketooth Harrow Bar and Crumbler Roller in series to work up and condition soil. It is a simple and reliable system that requires minimal maintenance.

In the following section, we have listed many of the problems, causes and solutions to the problems that you may encounter.

If you encounter a problem that is difficult to solve, even after having read through this trouble shooting section, please call your local dealer, distributor, or the factory. Before you call, please have this Operator's Manual and the serial number from your Soil Conditioner ready.

PROBLEM	CAUSE	SOLUTION
Shovel won't penetrate soil.	Hard ground conditions.	Replace shovels if badly worn.
		Be sure 3 point hitch is set in "float" mode.
		Add weight to frame.
		Make more than one pass to break up soil.
<hr/>		
High power required.	Wrong shovels.	Install smaller shovels.
	Shovels worn.	Replace shovels.
	Operating too deep.	Raise machine out of the ground slightly.
<hr/>		
Uneven job.	Changing soil conditions.	Make more passes to dry out the soil.
	Too wet.	Wait for soil to dry out.
<hr/>		
Surface is lumpy.	Too wet.	Wait for soil to dry out.
	Harrow Bar isn't contacting the ground.	Lower Harrow Bar into soil.

7 ASSEMBLY

The machine is shipped from the factory in a partially disassembled form that allows for easy and convenient shipping.

When preparing for the customer, follow this procedure:

1. Clear the area of bystanders, especially small children.
2. Use 2 men to guide or direct and handle the heavy and bulky components.
3. Use a crane, hoist or forklift of sufficient capacity and stability to handle the components.
4. Attach to the lifting device, remove tie-downs, lift from the truck and move to the assembly area. Drive slow and keep the machine close to the ground.
5. Cut the straps and lay the components out.
6. Mount the sweeps or shovels to the tines and tighten fasteners to their specified torque.



Fig. 10 SHIPPING CONFIGURATION



Fig. 11 S-TINE WITH SWEEP

7. Refer to the tine locations on the frame from the next page. Use a tape measure and mark each location.
8. Locate each tine at its marked position on the frame.

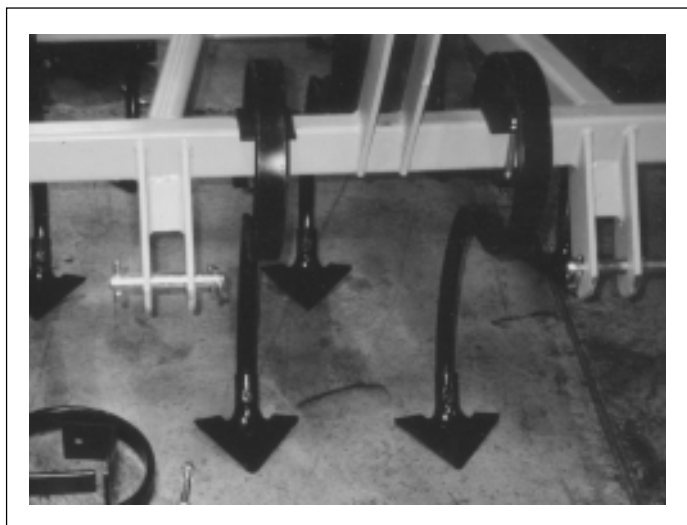

Fig. 12 TIGHTENING

9. Refer to appropriate drawing to define location of tines for your machine.

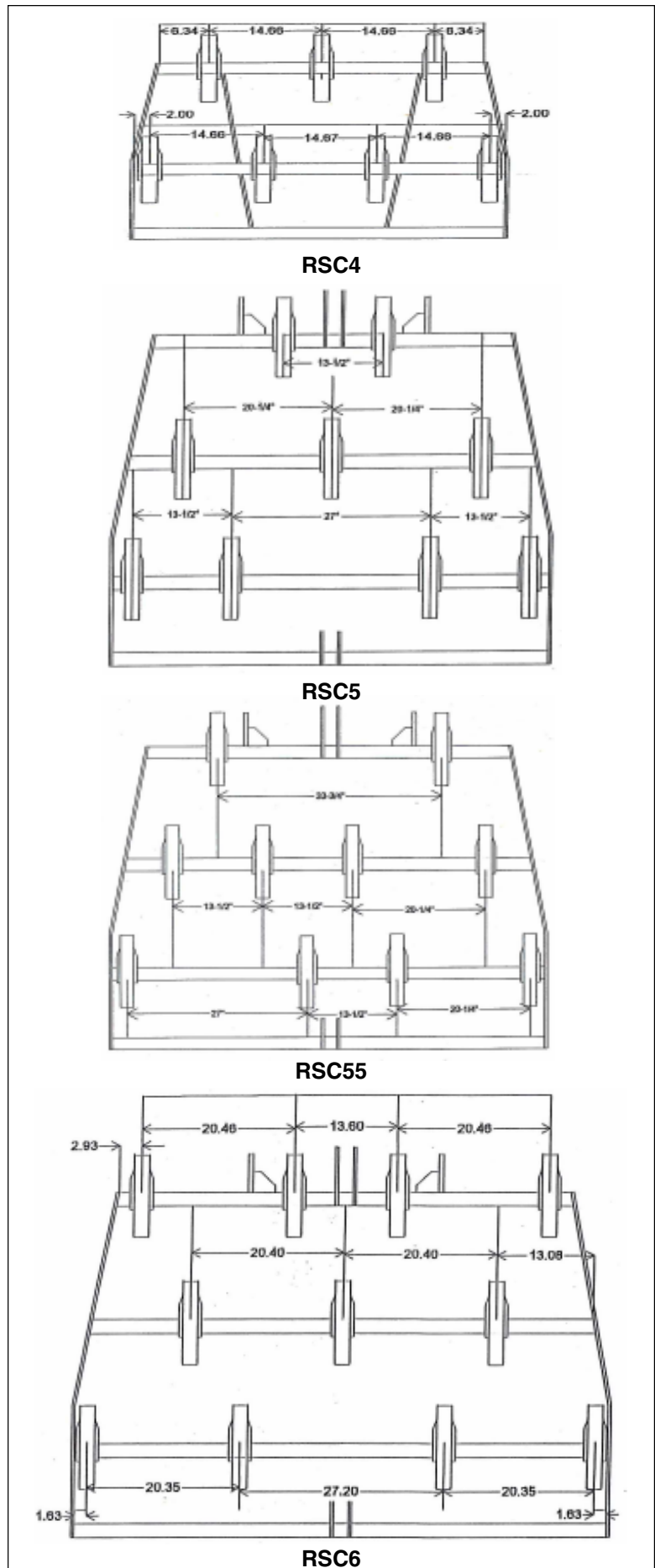

Fig. 13 TINE LOCATIONS

10. Refer to appropriate drawing to define location of tines for your machine.

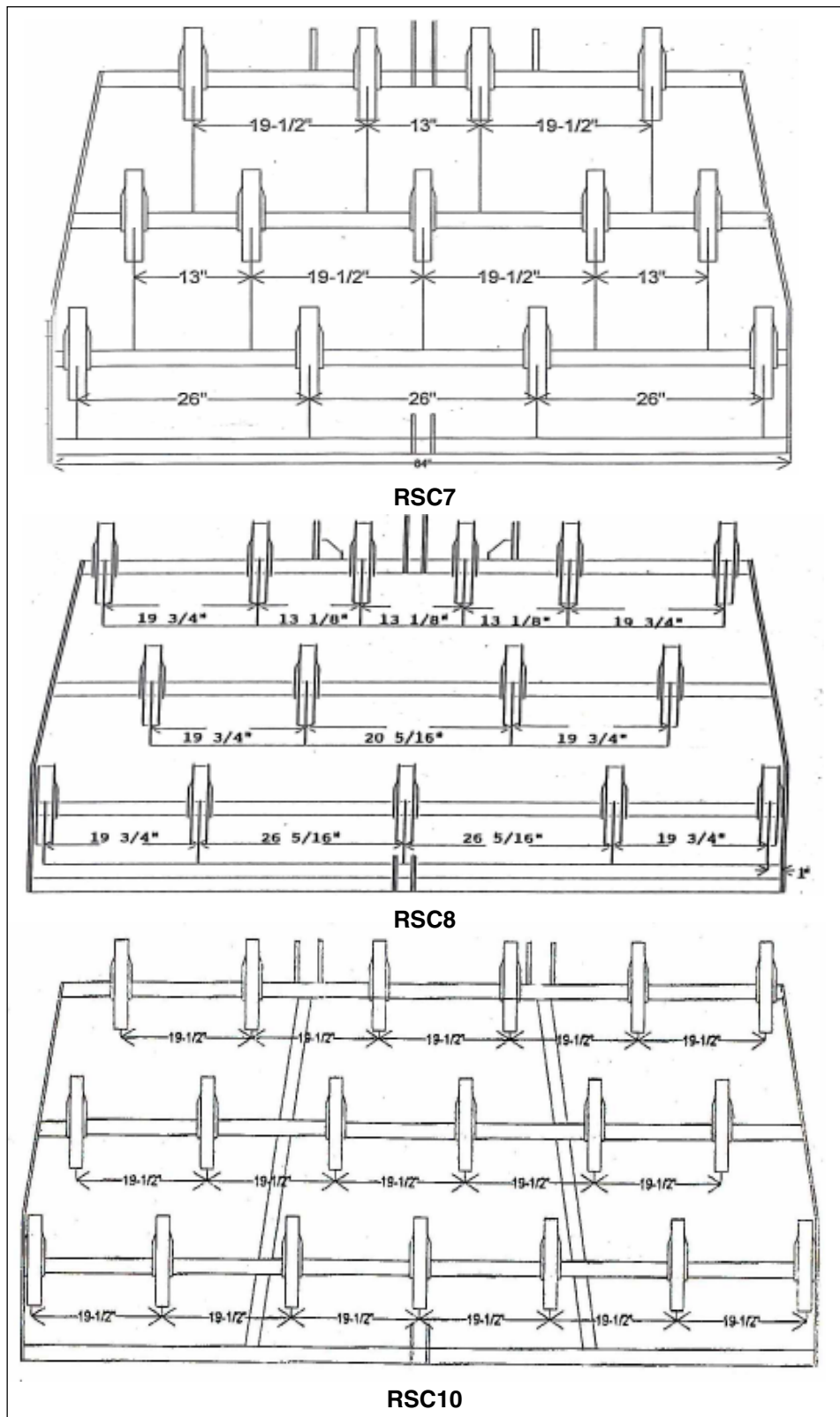

Fig. 14 TINE LOCATIONS

11. Refer to appropriate drawing to define location of tines for your machine.

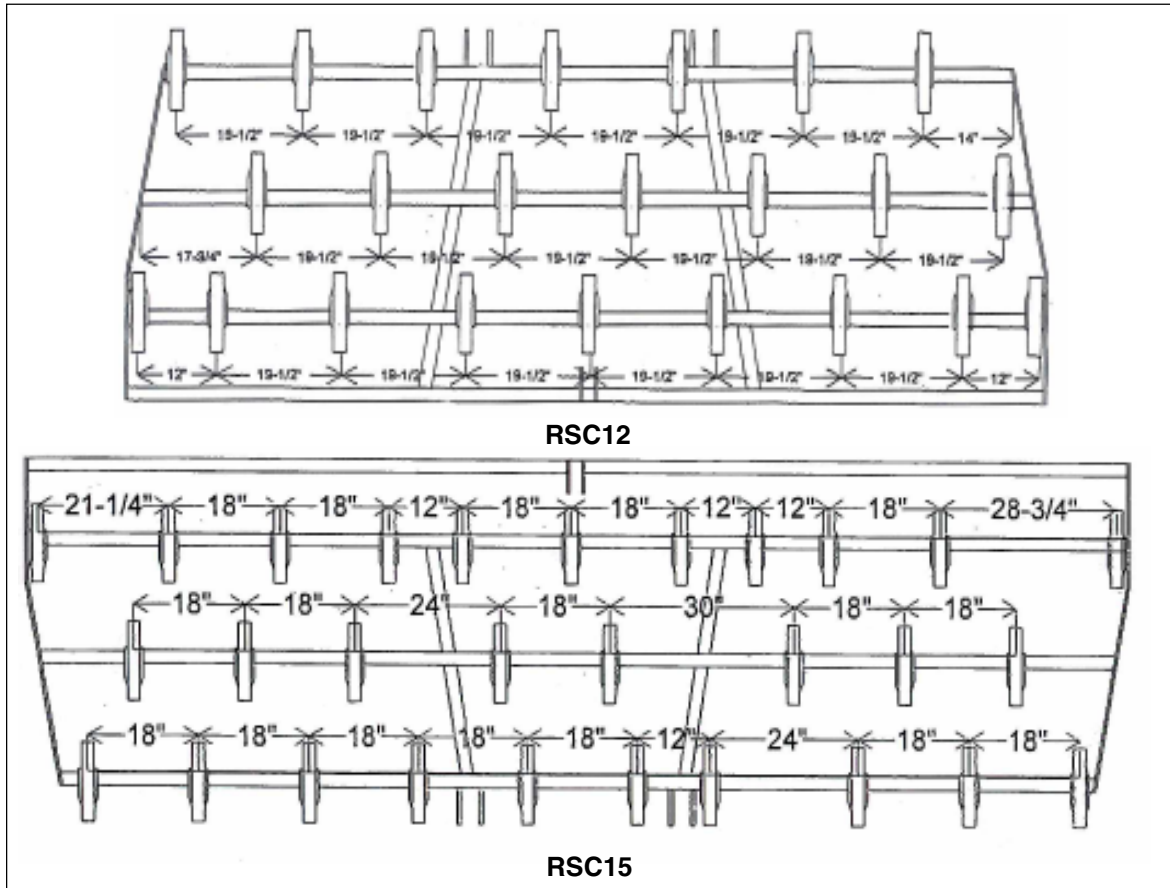

Fig. 15 TINE LOCATIONS

12. Mount the spring loaded supports to the rear of the cultivator frame.

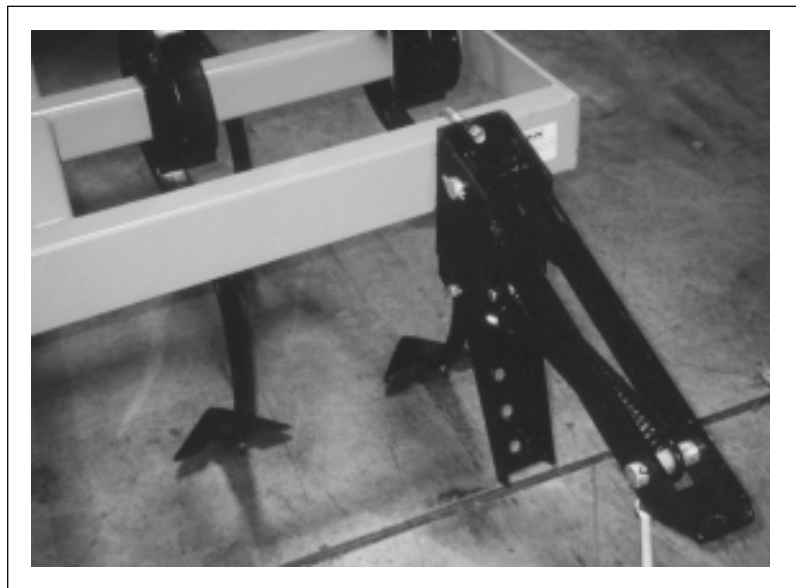

Fig. 16 SUPPORTS (TYPICAL)

13. Mount the Crumbler Roller to the supports.

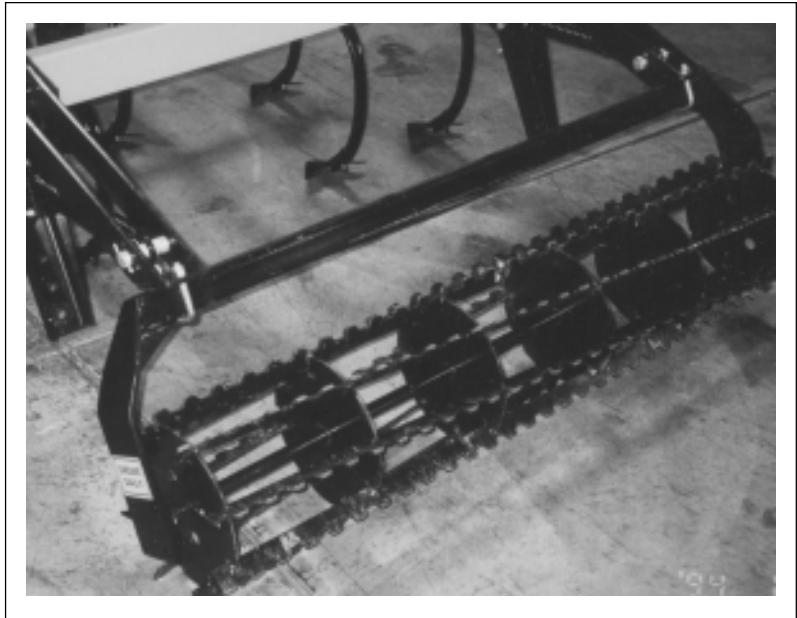

Fig. 17 CRUMBLER ROLLER

14. Mount the Spiketooth Harrow Bar to the support.
15. Tighten all fasteners to their specified torque.

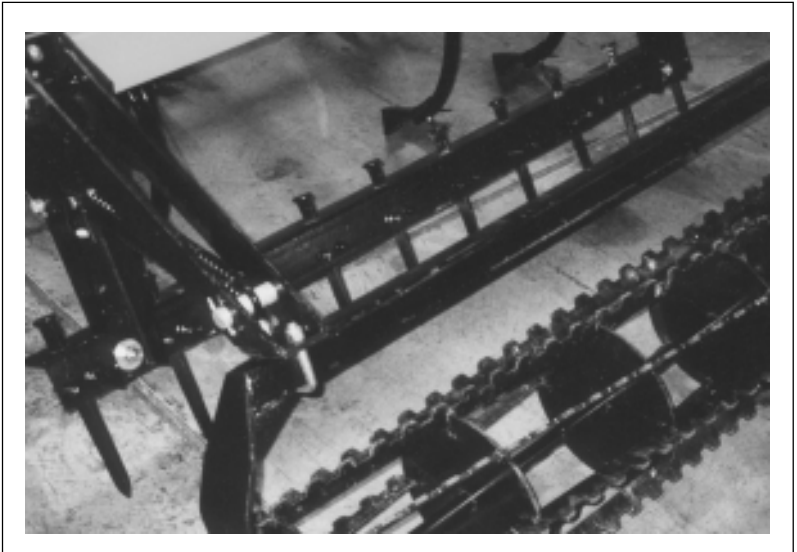

Fig. 18 SPIKETooth HARROW BAR

8 SPECIFICATIONS

8.1 MECHANICAL

MODELS	RSC4	RSC5	RSC5-5	RSC6	RSC7	RSC8	RSC10	RSC12	RSC15
WORKING WIDTH	4'	5'	5 1/2'	6'	7'	8'	10'	12'	15'
NO. OF SHANKS	7	9	10	11	13	15	19	23	29
SHANK SIZE	1 1/2" X 1 3/4"	1 1/2" X 1 3/4"	1 1/2" X 1 3/4"	1 1/2" X 1 3/4"	1 1/2" X 1 3/4"	1 1/2" X 1 3/4"	1 1/2" X 1 3/4"	1 1/2" X 1 3/4"	1 1/2" X 1 3/4"
SHANK CLEARANCE	20"	20"	20"	20"	20"	20"	20"	20"	20"
SHANK SPACING	6 1/2"	6 1/2"	6 1/2"	6 1/2"	6 1/2"	6 1/2"	6 1/2"	6 1/2"	6 1/2"
FRAME TUBE SIZE	(3) 2 X 3 (1) 2 X 4	(3) 2 X 3 (1) 2 X 4	(3) 2 X 3 (1) 2 X 4	(3) 2 X 3 (1) 2 X 4	(3) 2 X 3 (1) 2 X 4	(3) 2 X 3 (1) 2 X 4	(3) 2 X 3 (1) 2 X 4	(3) 2 X 3 (1) 2 X 4	(3) 2 X 3 (1) 2 X 4
HITCH	CAT. 1	CAT. 1	CAT. 1	CAT. 1	CAT. 1	CAT. 2	CAT. 2	CAT. 2	CAT. 2
HP RATING	14-25	18-32	20-35	22-39	26-46	30-53	38-67	46-81	58-102
APPROXIMATE WEIGHT	475	620	700	800	900	1000	1300	1620	1900
REVERSIBLE POINTS	OPT	OPT	OPT	OPT	OPT	OPT	OPT	OPT	OPT
7" SWEEPS	STD	STD	STD	STD	STD	STD	STD	STD	STD
GAUGE WHEELS	OPT	OPT	OPT	OPT	OPT	OPT	STD	STD	STD
REAR CRUMBLER	STD	STD	STD	STD	STD	STD	STD	STD	STD
REAR SPIKETooth BAR W/SHANKS	STD	STD	STD	STD	STD	STD	STD	STD	STD

SPECIFICATIONS ARE SUBJECT TO CHANGE WITHOUT NOTICE

8.2 BOLT TORQUE

CHECKING BOLT TORQUE

The tables shown below give correct torque values for various bolts and capscrews. Tighten all bolts to the torques specified in chart unless otherwise noted. Check tightness of bolts periodically, using bolt torque chart as a guide. Replace hardware with the same strength bolt.

ENGLISH TORQUE SPECIFICATIONS

Bolt Diameter "A"	SAE 2		SAE 5		SAE 8	
	N.m	(lb-ft)	N.m	(lb-ft)	N.m	(lb-ft)
1/4"	8	(6)	12	(9)	17	(12)
5/16"	13	(10)	25	(19)	36	(27)
3/8"	27	(20)	45	(33)	63	(45)
7/16"	41	(30)	72	(53)	100	(75)
1/2"	61	(45)	110	(80)	155	(115)
9/16"	95	(70)	155	(115)	220	(165)
5/8"	128	(95)	215	(160)	305	(220)
3/4"	225	(165)	390	(290)	540	(400)
7/8"	230	(170)	570	(420)	880	(650)
1"	345	(225)	850	(630)	1320	(970)



Torque figures indicated above are valid for non-greased or non-oiled threads and heads unless otherwise specified. Therefore, do not grease or oil bolts or capscrews unless otherwise specified in this manual. When using locking elements, increase torque values by 5%.

* Torque value for bolts and capscrews are identified by their head markings.

9 INDEX

A	PAGE
Assembly	22
I	
Introduction	1
O	
Operation	11
Field Operation	13
Machine Break-In	12
Machine Components	12
Pre-Operation Checklist	12
Storage	18
To the New Operator or Owner	11
Transporting	18

S	PAGE
Safety	2
Equipment Safety Guidelines	4
General Safety	3
Maintenance Safety	8
Operating Safety	7
Preparation	6
Safety Training	5
Safety Signs	5
Sign-Off Form	9
Storage Safety	8
Transport Safety	8
Safety Sign Locations	10
Service and Maintenance	19
Service	19
Fluid and Lubricants	19
Greasing	19
Service Record	20
Servicing Intervals	20
Specifications	27
Bolt Torque	28
Mechanical	27

T

Trouble Shooting	21
------------------------	----



**Manufactured by:
Northstar Attachments, LLC
101 Wagon Trail Dr.
Yakima, WA 98901**

**Distributed by:
Ford Distributing, Inc.
10784 Industrial Parkway
Marysville, OH 43040**

**Tel: 614-873-4620
Please visit www.forddistributing.com for online
warranty registration and replacement manuals**