



Operator's Manual



Hydraulic Post Driver

Model HD-10 & HD-10-H

Safety

Operation

Maintenance

Repair

Troubleshooting

Parts

Contents

Safety	2
Safety Alert Symbols	3
Safety Icon Nomenclature	3
Safety Warnings	4
General Safety	4
Hazard Avoidance	4
Hydraulic Hoses	5
Introduction	6
Product Information	6
Specifications	6
Assembly Procedure	7
Recommended Tools	7
Unpacking	8
Assembly	8
Main Carriage Channel	9
Stabilizer Legs	10
Base Plate	10
Hydraulic Valve	13
Safety Stop Adjustment	16
Rubber Debris Guard	17
Safety Arm	18
Document Storage Tube	21
Post Driver Operation	21
Operational Safety Tips	21
Operating Instructions	22
Mounting	22
Preparing to Drive a Post	23
Driving a Post	24
Dismounting Post Driver	27
Troubleshooting	29
Storage	29
Service Procedures	30
Three-Point Hitch/Post Driver Assembly	30
Main Carriage Channel Disassembly	31
Drive Cylinder Seal Replacement	33
Main Carriage Channel Assembly	35
Forward and Side Tilt Cylinder Maintenance	38
Cylinder Disassembly	38
Cylinder Assembly	39
Three-Point Hitch/Post Driver Assembly	41

Service Parts	42
Driver Assembly	42
Manual Base Plate Assembly	44
Hydraulic Base Plate Assembly	46
Three-Point Hitch Assembly	48
Hydraulic Hoses	48
Safety Arm Assembly	48
Replacement Decals	49
Document Tube	49
Hydraulic Control Valves	50
Single Control Lever Valve	50
Triple Control Lever Valve	51
Drive Cylinder Assembly	52
Expanded View of Safety Lever Assembly	52
Tilt Cylinder Assembly	53
Limited Warranty	54
Warranty Card	55

Safety

Most work related accidents are caused by failure to observe basic safety rules or precautions. An accident can often be avoided by recognizing potentially hazardous situations before an accident occurs. As you assemble and operate the Shaver Post Driver, you must be alert to potential hazards. You should also have the necessary training, skills, and tools to perform this assembly procedure.

Improper operation and maintenance of this implement could result in a dangerous situation that could cause injury or death.

Do not assemble, operate, or maintain the Shaver Post Driver until you read and understand the information contained in this manual.



Safety precautions and warnings are provided in this manual and on the product. If these hazard warnings are not heeded, bodily injury or death could occur to you or to other persons.

Shaver Manufacturing Company cannot anticipate every possible circumstance that might involve a potential hazard. The warnings in this supplement and on the product are, therefore, not all-inclusive. If a method of operation not specifically recommended by Shaver Manufacturing Company is used, you must satisfy yourself that it is safe for you and for others. You should also ensure that the implement will not be damaged or be made unsafe by the methods that you choose.

The information, specifications, and illustrations in this supplement are based on the information that was available at the time this material was written and can change at any time.

Safety Alert Symbols



The safety alert symbol means **Attention! Become Alert! Your Safety is Involved.**

Hazards are identified by the “Safety Alert Symbol” and are followed by the signal word “WARNING”.

WARNING

WARNING: Indicates a potentially hazardous situation which, if not avoided, could result in death or serious injury.

Potential damage situations are identified by the signal words “IMPORTANT NOTICE”.

IMPORTANT NOTICE

Indicates that equipment or property damage can result if instructions are not followed.

Safety Icon Nomenclature



Read the manual



Eye protection



Foot protection



Hand protection



Hearing protection



Inspect equipment



Two person operation



Warning decal alert



Bending hazard (hydraulic hose)



Crushing hazard



Crushing hazard (hand)



Do not weld



Electrocution hazard



Explosion hazard



High-pressure fluid hazard



Impact hazard (hydraulic hose)



Pressurized fluid



Projectile hazard (body)



Protective guards



Safety alert symbol



Slipping hazard



Tripping hazard

Safety Warnings

General Safety

WARNING



To avoid personal injury or death, carefully read and understand all instructions before attempting to assemble and/or operate the Post Driver. Do not operate or work on equipment unless you read and understand the instructions and warnings in this and all other applicable manuals. Contact Shaver Manufacturing Company, if any of the instructions provided are unclear or not understood. Proper care is your responsibility. Always follow all State and Federal health and safety laws and/or local regulations.



To help prevent personal injury, protective equipment must be worn during Post Driver assembly, operation, and maintenance. Personal protective equipment should include, but not be limited to, safety glasses, hearing protection, protective gloves, and steel toe footwear.



Personal injury can result from slips or falls. DO NOT leave tools or parts laying around the work area, and clean up all spilled fluids immediately.

Hazard Avoidance

WARNING



Inspect this equipment before each use. Make sure all hardware is tight. Always replace worn or damaged parts before use.



To avoid personal injury or death, do not operate the Post Driver by yourself. Always have another person to control the machine or power source.

WARNING



Make sure all decals are securely attached to the Post Driver and are legible at all times. Always read and understand all decals before working on or operating the Post Driver.



Make sure all lock-pins and transport supports are secured in place before transporting or storing the Post Driver. While transporting, never ride on or permit others to ride on the Post Driver.



Improper operating procedures can create risk for the operator and bystanders. DO NOT use the Post Driver before making sure no one will be endangered.



To prevent personal injury or death, be aware of overhead electrical lines when operating the Post Driver. Electrocutation can occur even without direct contact with overhead power lines. Proceed cautiously around electrical lines and utility poles.



To prevent personal injury or death, always check for underground utilities, such as electrical wires, gas lines, and water pipes, before driving posts. Contact local utility companies for information on locating underground utilities.



To avoid serious injury or death, do not operate the Post Driver on steep slopes, as this can cause a roll over.



To avoid personal injury, always stand 45 degrees to the right of the post being driven while operating the Post Driver.

! WARNING



Potential pinch points. Keep hands clear of Post Driver while operating. Never place hand(s) on top of a post when inserting it into the Post Driver. Always close the safety arm before driving the post.



To avoid personal injury do not attempt to clean, adjust, or lubricate the Post Driver while it is in motion.



The rubber debris guard helps shield the operator from flying debris that may be generated during post driving. To avoid personal injury, make sure the rubber debris guard is securely attached to the Post Driver before driving posts.



To avoid personal injury or death, do not modify the Post Driver by welding, drilling, or grinding. Do not expose to extreme heat, such as from a torch.



The main carriage channel assembly is tall and heavy. To avoid tip over, resulting in serious injury or death, leave the overhead lifting device attached to the main carriage channel while assembling components.



To avoid serious injury or death, the safety arm must be installed after the Post Driver has been mounted on a machine, or the freestanding Post Driver has been secured to prevent tipping.

Hydraulic Hoses

! WARNING



Avoid damaging hydraulic hoses. Avoid sharp bends and kinks when routing hydraulic hoses. Using a bent or kinked hose will cause severe back-pressure. Sharp bends and kinks can internally damage the hose, leading to premature hose failure, resulting in personal injury.

! WARNING



Do not drop heavy objects on hoses. A sharp impact may cause internal damage to the hose. Applying pressure to a damaged hose may cause it to rupture, resulting in personal injury.

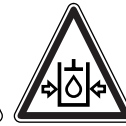

Mismatched couplings and hoses can cause the coupling to violently disconnect from the hose when placed under pressure; separating with sudden, extreme force which can result in property damage, personal injury, or death.

Replace a hose if any of the following conditions are present:

- End fittings that are damaged or leaking
- Outer coverings that are chafed or cut
- Wire shields that are exposed
- Outer coverings that are ballooning
- Flexible part of the hoses that are kinked
- End fittings that are displaced



Pressure can be trapped in a hydraulic system. Trapped pressure can cause sudden movement of an attachment. Use caution when disconnecting hydraulic lines or fittings. High-pressure oil that is released can cause a hose to move violently while spraying oil.



Escaping high-pressure fluid can penetrate the skin, causing serious injury. Relieve pressure before unhooking hoses. Check/tighten all connections before activating hydraulics. Never use your hand to check for leaks.

Introduction

The Shaver Manufacturing Company would like to congratulate you on your purchase of the Shaver Hydraulic Post Driver. You have selected the best Post Driver in its class. The clean design and uncomplicated working principle have made Shaver the largest selling Post Driver in the country.

The Shaver HD-10 (manual tilt adjustment) and HD-10-H (hydraulic tilt adjustment) Hydraulic Post Driver is a durable piece of equipment that, with regular maintenance, will provide many years of service.

This manual provides information regarding assembly, operation, and maintenance. It is important to read and become familiar with this manual before assembling or operating the Shaver Hydraulic Post Driver.

NOTE: For other valuable information on farm equipment operation and safety, refer to the following resources.

- **Farm Equipment Manufacturers Association (FEMA)**
<http://www.farmequip.org/home>
- **National Ag Safety Database**
<http://www.cdc.gov/nasd/>

Product Information

Record Shaver product information here. The model number and serial number are found on the metal tag attached to the drive ram.



Model Number _____

Serial Number _____

Date Purchased _____

Dealer Name _____

Specifications

HD-10 & HD-10-H Post Driver	
Approximate Length ¹	100 in (254 cm) collapsed 148 in (376 cm) extended
Approximate Width ²	44 in (111.8 cm)
Approximate Depth ²	33 in (88.8 cm)
Shipping Weight	694 lbs (315 kg) manual base 714 lbs (324 kg) hydraulic base
Effective Weight of Spring Powered Driving Ram	725 lbs (329 kg)
Impact (at full stroke)	71,500 lbs (32,432 kg)
Main Carriage Channel	
Tilt Front/Back	15°/15°
Tilt Side/Side	15°/15°
Guide Blocks	4 (2 per side)
Mounting Options	Tractor (rear/front) and skid steer
Three-Point Hitch	Category II and III
Hydraulic Requirements	12 GPM at 1500 PSI (45 LPM at 10,342 kPa)
Post Size	
Maximum Width	8.75 in (22.2 cm)
Maximum Length	10 ft (3.0 m)

¹ Driving ram and main carriage channel. Overall height will vary, depending on mounting position and tractor.

² With stabilizer legs attached to three-point hitch weldment.

Assembly Procedure

Recommended Tools

The basic tools needed to assemble and maintain the HD-10 and HD-10-H Post Driver are shown below. Additional specialized tools may be required.

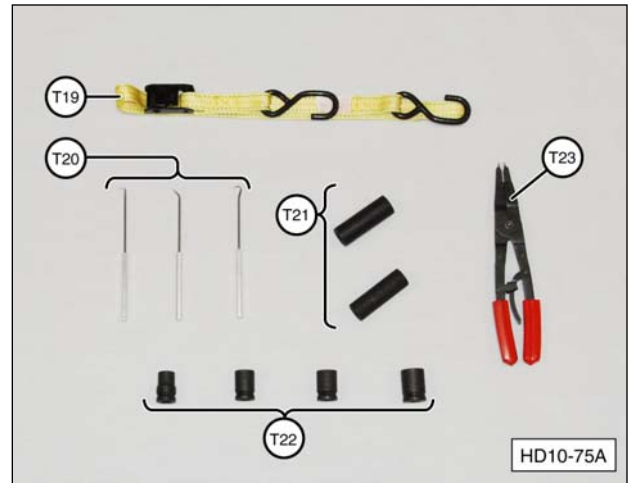
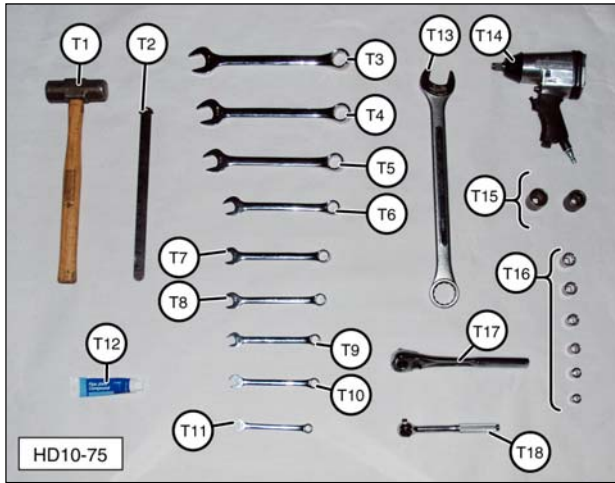

HD-10 and HD-10-H Recommended Tools		
No.	Description	Qty
T1	Mallet or Hammer	1
T2	Straight Edge	1
T3	1-1/8 Inch Combination Wrench	1
T4	1-1/16 Inch Combination Wrench	1
T5	15/16 Inch Combination Wrench	1
T6	3/4 Inch Combination Wrench	1
T7	11/16 Inch Combination Wrench	1
T8	5/8 Inch Combination Wrench	1
T9	9/16 Inch Combination Wrench	1
T10	1/2 Inch Combination Wrench	1
T11	7/16 Inch Combination Wrench	1
T12	Paste-Type Thread Sealant	AR
T13	1-1/2 Inch Combination Wrench	1
T14	1/2 Inch Drive Impact Gun	1
T15	1-1/2 Inch Impact Socket	1
	1-1/16 Inch Impact Socket	1
T16	3/8 and/or 1/2 Inch Drive Socket Set (9/16, 5/8, 11/16, 3/4, 15/16, 1 Inch)	AR
T17	1/2 Inch Drive Ratchet	1
T18	3/8 Inch Drive Ratchet	1

HD-10 and HD-10-H Recommended Tools (continued)		
No.	Description	Qty
T19	Heavy-Duty Retaining Strap	1
T20	Heavy-Duty Seal Picks ¹	AR
T21	9/16 Inch Deepwell Impact Socket	1
	1/2 Inch Deepwell Impact Socket	1
T22	9/16 Inch Impact Socket	1
	5/8 Inch Impact Socket	1
	11/16 Inch Impact Socket	1
	3/4 Inch Impact Socket	1
T23	Heavy-Duty Snap Ring Pliers ¹	1
—	Soft Brass or Wood Drift ¹ (not shown)	1

¹ Required for cylinder seal replacement.

AR - As Required

Unpacking

⚠ WARNING



Due to the size and weight of the Post Driver, two people are required for the assembly procedures.

The Post Driver is shipped in several sections: the driving ram assembly, base plate assembly, short channel bracket, hose and valve carton, safety arm carton, and on model HD-10-H, the tilt cylinder carton.

⚠ WARNING



Before starting the unpacking procedure, make sure the overhead lifting device or material handling device (forklift) has adequate lifting capacity. Follow all safety recommendations when unpacking the Post Driver. Some components are heavy and can cause serious injury or death if not adequately supported during removal and assembly.

For ease of assembly, unload the Post Driver components in the area where they will be assembled. Choose a large, hard surface area that can safely support the weight of the assembled Post Driver and is accessible by the machine it will be mounted on.



Assembly

NOTE: Refer to the Service Parts section of this manual for a photo and description of all the parts.

The HD-10 main carriage channel has provisions for mounting the short carriage channel bracket in three positions.

- Six middle bolt holes - three-point hitch (most common position).
- Six upper bolt holes - tractor front mount.
- Six lower bolt holes - for driving 10 ft (3.0 m) tall posts only - three-point hitch or front tractor mount.

The HD-10 and HD-10-H are shipped with the carriage channel bolts installed in the middle mounting position.

The Post Driver assembly procedure consists of the following subsections:

1. Main Carriage Channel
2. Stabilizer Legs
3. Base Plate
4. Hydraulic Valve
5. Safety Stop Adjustment
6. Rubber Debris Guard
7. Safety Arm
8. Document Storage Tube

Main Carriage Channel

1. With road lock pin (B8) installed in lower hole of drive ram (A1), use a suitable overhead lifting device to raise (stand up) main carriage channel (B1).

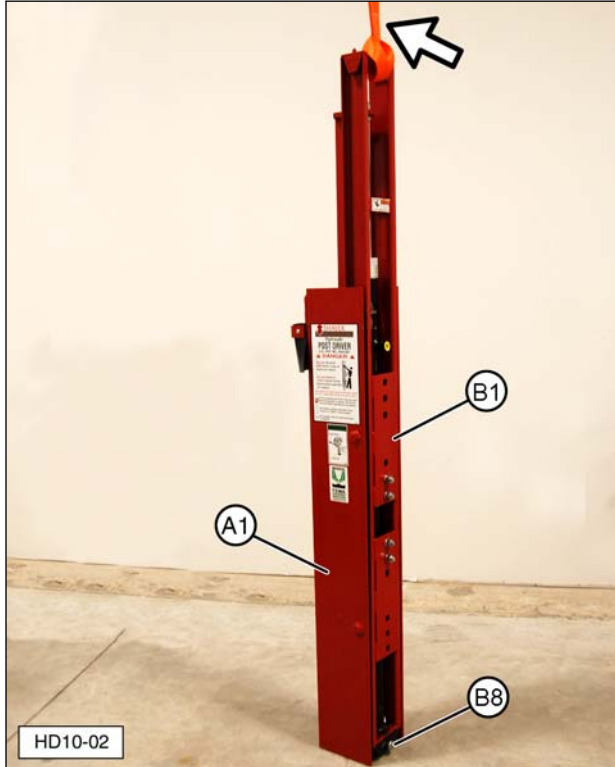

(A1) Drive Ram. (B1) Main Carriage Channel.
(B8) Road Lock Pin.

⚠ WARNING



The main carriage channel assembly is tall and heavy. To avoid tip over, resulting in serious injury or death, leave the overhead lifting device attached to the main carriage channel while assembling components.

2. Install appropriate short channel bracket (D1, D2) using bolts (D3) and lock washers (D4) (6 each). Tighten completely.

NOTE: Hydraulic short channel bracket (D2) shown. Manual short channel bracket (D1) installation is the same.

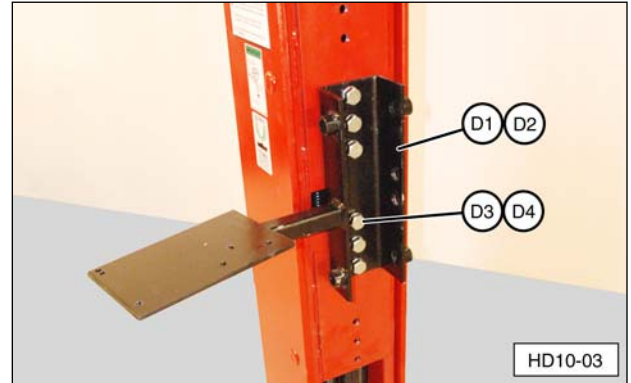

(D1) Manual Short Channel Bracket (not shown).
(D2) Hydraulic Short Channel Bracket (shown).
(D3) Bolt. (D4) Lock Washer.

3. Remove road lock pin (B8) from lower hole in drive ram (A1). Use spring tension to help raise main carriage channel (B1) and insert road lock pin (B8) in upper hole (tool storage position) in drive ram (A1). Install Lynch pin (B9), not shown, to secure road lock pin.

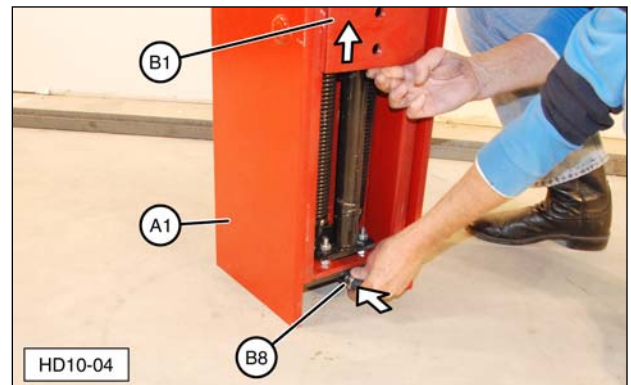

(A1) Drive Ram. (B1) Main Carriage Channel.
(B8) Road Lock Pin.

Stabilizer Legs

1. Place three-point hitch weldment (K1) upside down on the floor. Install stabilizer leg brackets (K2), with stabilizer legs (K7) installed, over the cross tube, as shown. Tighten two leg bracket bolts (K3) to secure the brackets to the cross tube.

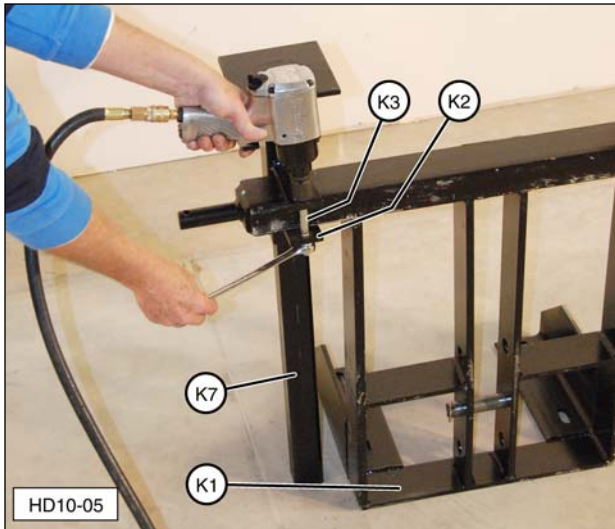

(K1) Three-Point Hitch Weldment. (K2) Leg Bracket.
(K3) Leg Bracket Bolt. (K7) Stabilizer Leg.

2. Set stabilizer leg (K7) height at 8" (20.3 cm) measured from three-point hitch weldment (K1) cross tube to the stabilizer leg base plate, as shown. Tighten the stabilizer leg lock bolts.

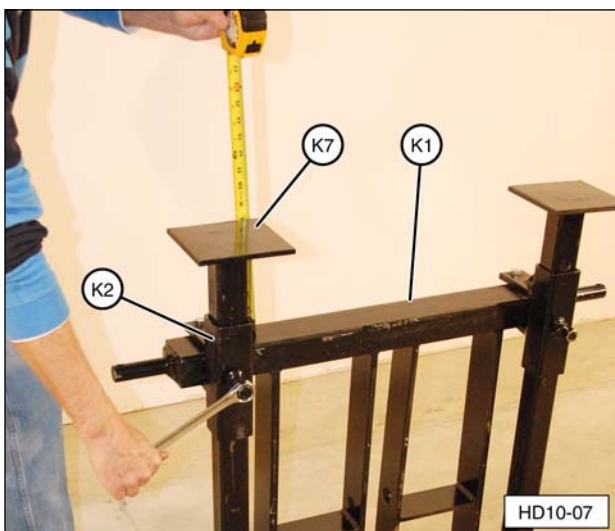

(K1) Three-Point Hitch Weldment. (K2) Leg Bracket.
(K7) Stabilizer Leg.

NOTE: If a different set of holes was used to mount channel bracket (D1 or D2), the height of the legs will need to be adjusted accordingly.

3. Turn over three-point hitch weldment (K1) and set it on stabilizer leg (K7) base plates, as shown.

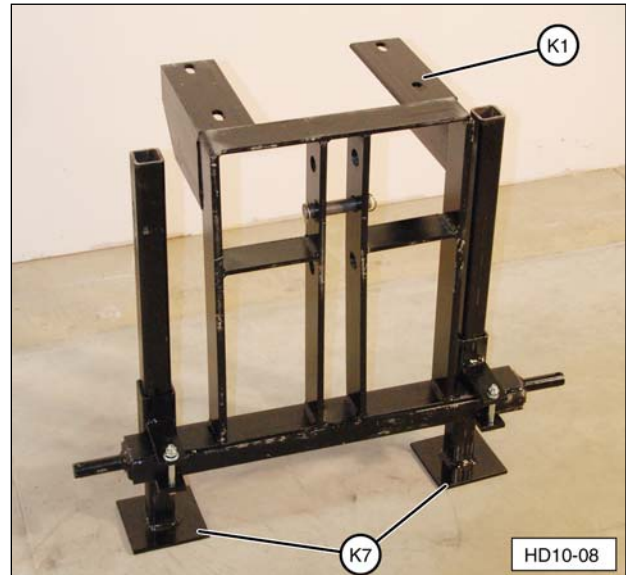

(K1) Three-Point Hitch Weldment. (K7) Stabilizer Legs.

Base Plate

NOTE: Hydraulic base plate (F2) installation is shown. Installation of manual base plate (E2) is similar.

IMPORTANT NOTICE

Hydraulic system fittings that require a thread sealant must be installed with a paste-type sealer only. Do not use a tape-type sealer, such as Teflon Tape, as this can contaminate the system and voids the valve warranty.

1. Remove the carriage bolts, washers, and nuts from hydraulic base plate (F2). Save the hardware for reuse.

2. Install hydraulic base plate (F2) on three-point hitch weldment (K1), as shown. Install carriage bolts, washers, lockwashers, and nuts removed in Step 1. Center the base plate on the three-point hitch and tighten the hardware securely.

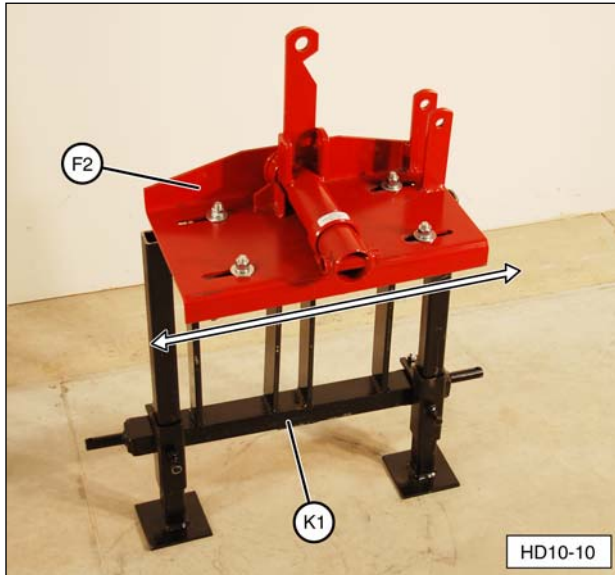

(F2) Hydraulic Base Plate. (K1) Three-Point Hitch Weldment.

3. Locate tilt cylinders (F3, F4). Install four hose assemblies (H5) using paste-type thread sealant (T12) on the fittings. Tighten the hose fittings securely.

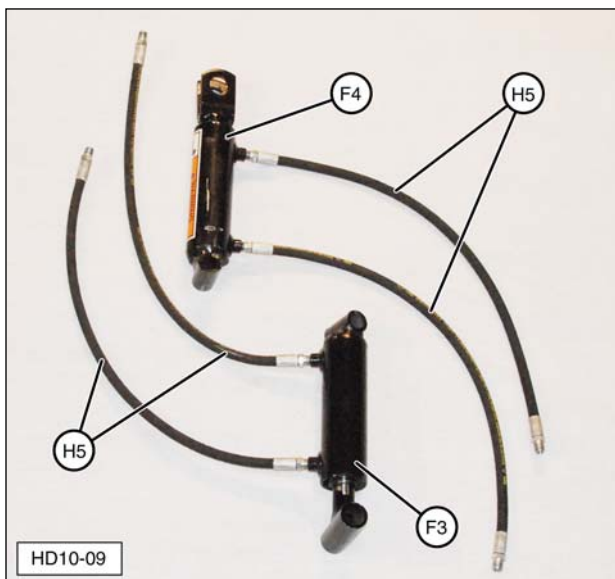

(F3) Forward Tilt Hydraulic Cylinder. (F4) Side Tilt Hydraulic Cylinder. (H5) Hydraulic Cylinder Hose Assembly.

4. Install hydraulic cylinders (F3, F4) on hydraulic base plate (F2), along with safety lever (F9, F10), as shown. Secure with Lynch pins (included).

NOTE: Side tilt cylinder (F4) is secured with cylinder mounting pins (F7, F8). Forward tilt cylinder (F3) and safety lever (F9, F10) are secured with cylinder mounting pin (F7) and channel mounting pin (D6).

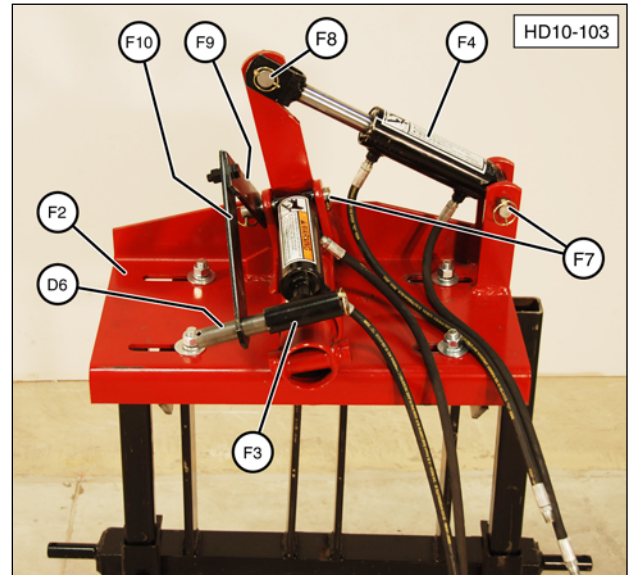

(D6) Channel Mounting Pin. (F2) Hydraulic Base Plate. (F3) Forward Tilt Hydraulic Cylinder. (F4) Side Tilt Hydraulic Cylinder. (F7) Long Cylinder Mounting Pin. (F8) Short Cylinder Mounting Pin. (F9, F10) Safety Lever.

⚠ WARNING



The main carriage channel assembly is tall and heavy. To avoid tip over, resulting in serious injury or death, leave the overhead lifting device attached to the main carriage channel while assembling components.

5. Install the hydraulic base plate on the short channel bracket.
 - a. Get assistance to position hydraulic base plate (F2) in front of hydraulic short channel bracket (D2).
 - b. Manually extend forward tilt cylinder and install upper channel mounting pin (D6) through short channel bracket (D2) and safety lever (F9). Make sure safety lever link (F9) is installed on upper channel mounting pin (D6), as shown. Secure with Lynch pins (included).
 - c. Start lower channel mounting pin (D6) in lower short channel bracket, as shown.

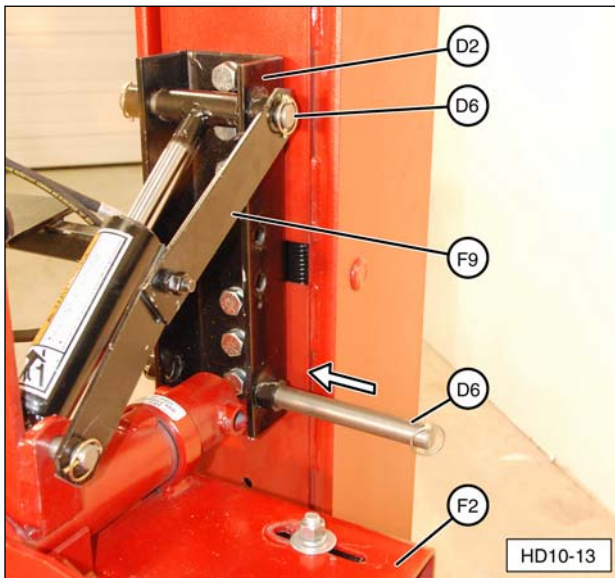

(D2) Short Channel Bracket. (D6) Short Channel Bracket Mounting Pin. (F2) Hydraulic Base Plate. (F9) Safety Lever Link.

- d. Use a suitable floor jack to support the three-point hitch weldment.
- e. Loosen stabilizer leg lock bolts (K8), and adjust floor jack up or down to align base plate pivot pin hole with short channel (D2) lower mounting hole.
- f. Install lower channel mounting pin (D6) and secure with Lynch pins. Tighten the two stabilizer leg lock bolts and remove the floor jack.

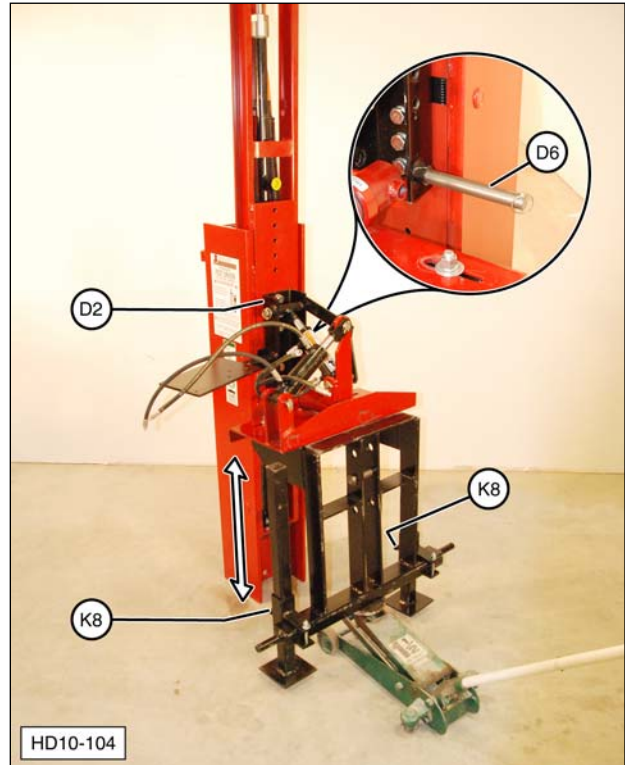

(D2) Hydraulic Short Channel Bracket.
(K8) Stabilizer Leg Lock Bolts.

NOTE: If using manual base plate (E2) assembly, adjust forward tilt crank (E11) and side tilt crank (E3) to align channel mounting pin holes. Install lower channel mounting pin (D6) first and then upper channel mounting pin. Secure pins with Lynch pins (included).

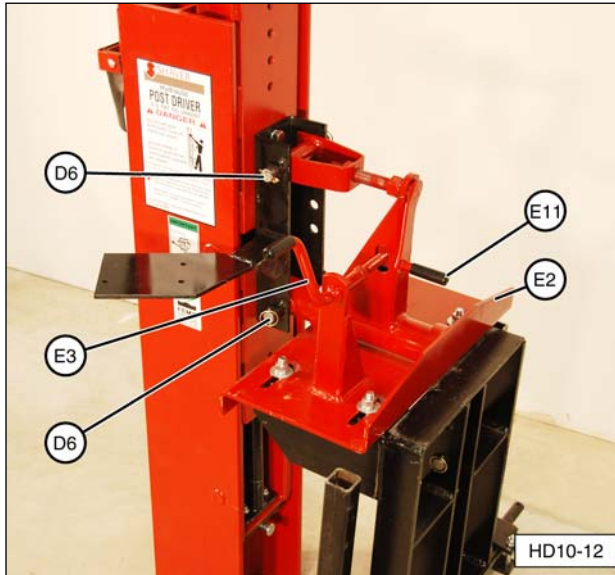

(D6) Channel Mounting Pin. (E2) Manual Base Plate. (E3) Side Tilt Crank. (E11) Forward Tilt Crank.

Hydraulic Valve

The customer must supply suitable hydraulic quick disconnect fittings for connecting pressure supply hose (G17) and return hose (G20) to the tractor or power supply hydraulic system.

IMPORTANT NOTICE

Hydraulic system fittings that require a thread sealant must be installed with a paste-type sealer only. Do not use a tape-type sealer, such as Teflon Tape, as this can contaminate the system and voids the valve warranty.

1. Assemble the hydraulic control valve. Single lever control valve (G1) for manual base plate or triple lever control valve (H1) for hydraulic base plate.

- a. Remove the plugs from the hydraulic control valve. Apply paste-type thread sealant (T12) to pipe threads and install hydraulic fittings (G16, G18, G19, G21), and on triple lever control valve, four tilt cylinder hose fittings (H3). Refer to photographs for correct placement and orientation.

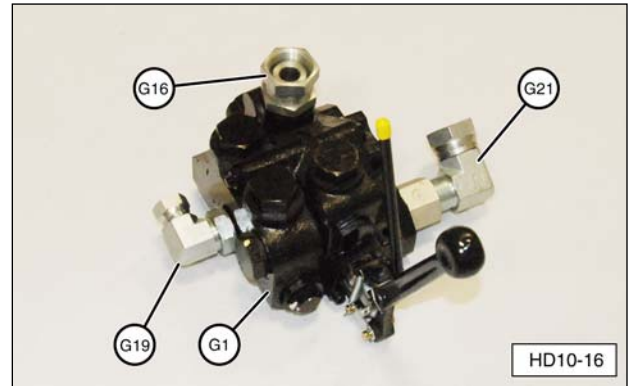

(G1) Manual Tilt Base Control Valve.

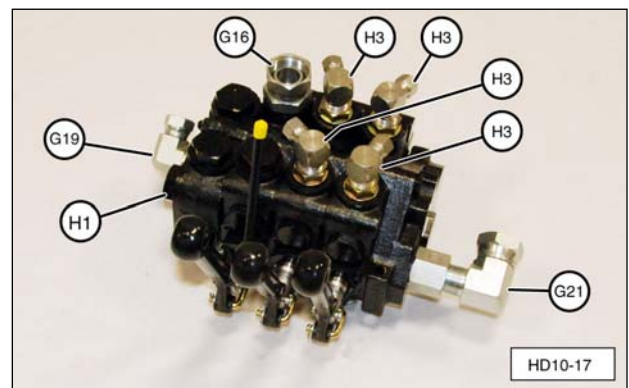

(H1) Hydraulic Tilt Base Control Valve.

(G16) Swivel Fitting:
3/4" O-Ring Male to 1" Female NPT.

(G19) 90° Swivel Fitting:
1-1/16" O-Ring Male to 1/2" Female.

(G21) 90° Swivel Fitting:
3/4" Male to 1" NPT Female with
Adapter Fitting:
1-1/16" O-Ring Male to 3/4" NPT Female.

(H3) 90° O-Ring Swivel Fitting (with restrictor):
7/8" Male to 1/4" Female.

- b. Assemble control valve linkage. Install lever(s) (G5), control valve safety lever (G7), return spring (G10), and lever linkage (G11, G12, G23), as shown. Secure with cotter pins (G13). Refer to photographs for correct placement and orientation.

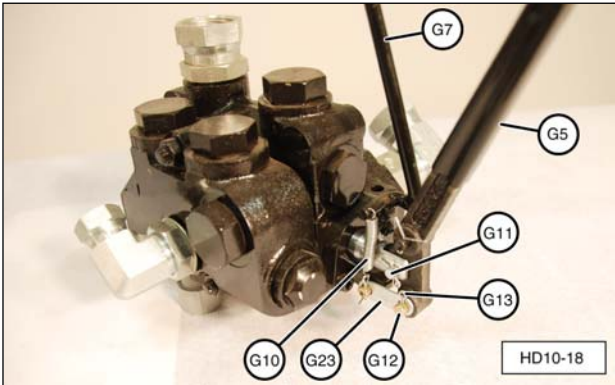

(G1) Manual Tilt Base Control Valve.

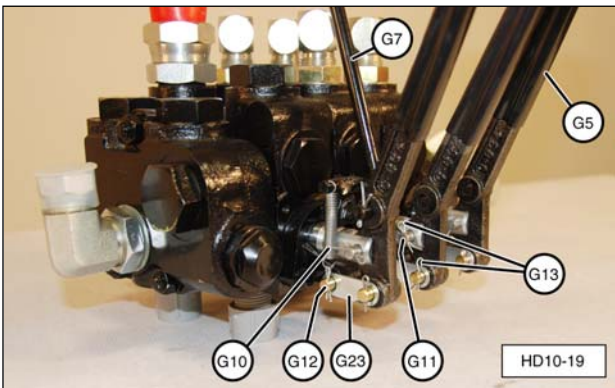

(H1) Hydraulic Tilt Base Control Valve.
 (G5) Control Valve Lever(s). (G7) Control Valve Safety Lever. (G10) Safety Lever Return Spring. (G11) Clevis Pin. (G12) U-Link. (G13) Cotter Pin(s). (G23) Flat Link.

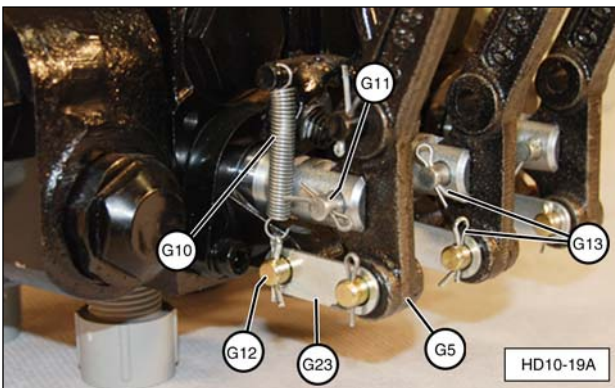

(H1) Hydraulic Valve Control Lever Linkage.
 (G5) Control Valve Lever(s). (G10) Safety Lever Return Spring. (G11) Clevis Pin. (G12) U-Link. (G13) Cotter Pin(s). (G23) Flat Link.

2. Install the hydraulic valve on short channel bracket (D1, D2) using three 5/16-18 x 3" valve mounting bolts (G2), washers (G3), and nuts (G4). Do not over-tighten the hardware, which can warp valve body.

NOTE: Single lever hydraulic valve shown. Installation of three lever hydraulic valve is the same.

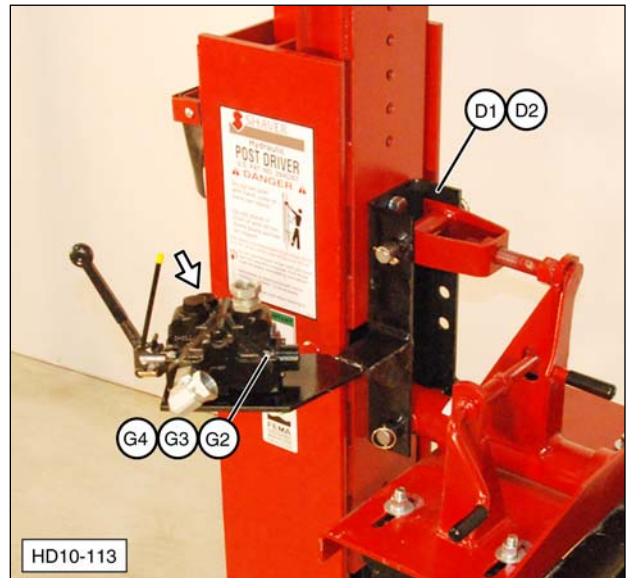

(D1) Hydraulic Short Channel Bracket. (D2) Manual Short Channel Bracket, shown. (G2) Bolt. (G3) Washer. (G4) Nut.

IMPORTANT NOTICE

The hydraulic valve and cylinder(s) can be damaged by contamination (dirt and debris) from the oil in the tractor or power source. Ensure the oil is clean and properly filtered before connecting the Post Driver to a hydraulic power source. Failure to follow oil cleanliness standards voids the Shaver Post Driver warranty.

3. Attach the hydraulic hoses.



(G15) Valve to Drive Ram Hose. (G17) Pressure Supply Hose. (G20) Return Hose.

- a. Apply paste-type thread sealant (T12) to hose fitting threads and install hose (1" I.D. x 35") (G15) between hydraulic control valve (G1 or H1) and drive cylinder assembly (C1). Tighten the hose fittings securely.

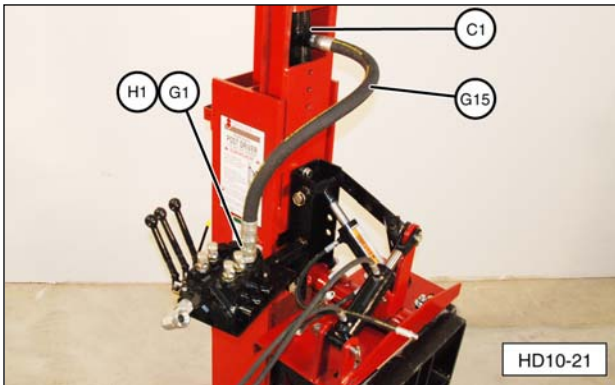

(C1) Drive Cylinder Assembly. (G1) Control Valve (Single Lever), not shown. (G15) Valve to Drive Ram Hose. (H1) Control Valve (triple lever).

- b. Connect threaded fitting on pressure hose (1/2" x 120") (G17) to control valve (G1 or H1) swivel fitting.
- c. Connect threaded fitting on return hose (1" x 120") (G20) to control valve (G1 or H1) swivel fitting.

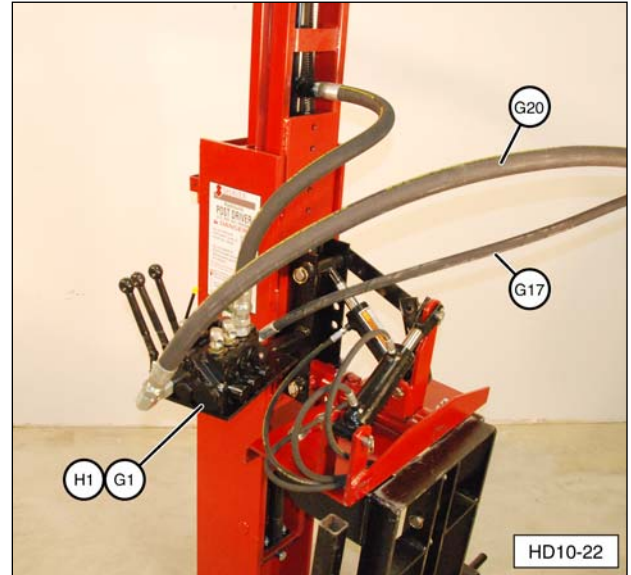

(G1) Single Lever Control Valve, not shown. (G17) Pressure Hose. (G20) Return Hose. (H1) Triple Lever Control Valve.

NOTE: The hydraulic control valve for manual base plate (E2) has a single control lever. Installation of supply, return, and drive ram hoses are the same.

IMPORTANT NOTICE

If the tilt cylinder hoses are attached differently than shown, the control of the drive ram will not be as described in this manual.

- d. Hydraulic base plate only. Attach forward tilt cylinder hoses (H5) between forward tilt cylinder (F3) and triple lever control valve (H1), as shown.

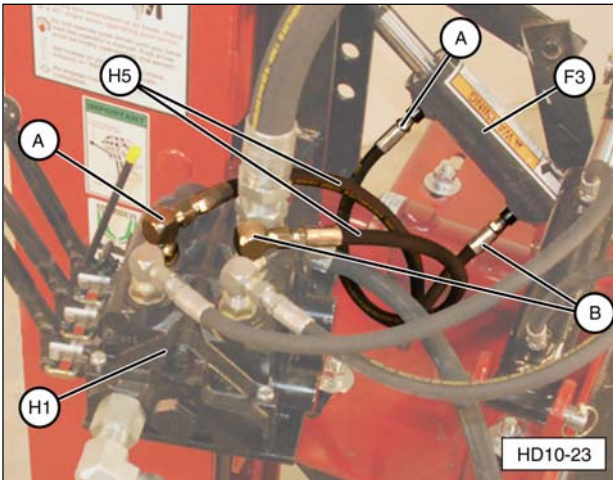

(F3) Forward Tilt Cylinder. (H1) Triple Lever Control Valve. (H5) Tilt Cylinder Hoses.

- e. Hydraulic base plate only. Attach side tilt cylinder hoses (H5) between side tilt cylinder (F4) and triple lever control valve (H1), as shown.

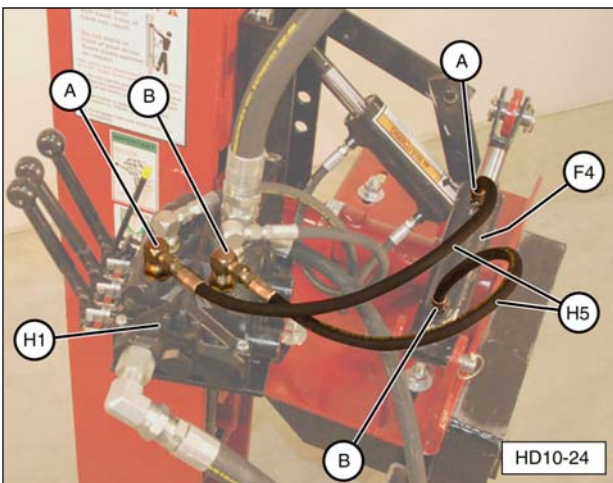

(F4) Side Tilt Cylinder. (H1) Triple Lever Control Valve. (H5) Tilt Cylinder Hose.

Safety Stop Adjustment

⚠ WARNING



To avoid serious injury, inspect the control valve safety stop before using the Post Driver the first time and/or before each daily use. Adjust the safety stop as needed, per the following procedure. Make sure all control valve hardware is tight. Always replace worn or damaged parts before use.

The control valve safety stop prevents unintentional activation of the Post Driver control valve and must be functional at all times.

If the Post Driver is operational, make sure the machine/power source is OFF, parking brake is set, road lock pin is installed, and all hydraulic pressure is released (zero pressure).

1. Attempt to push main hydraulic control valve lever (G5) forward (away from operator) without squeezing (pulling) yellow tipped control valve safety lever (G7).

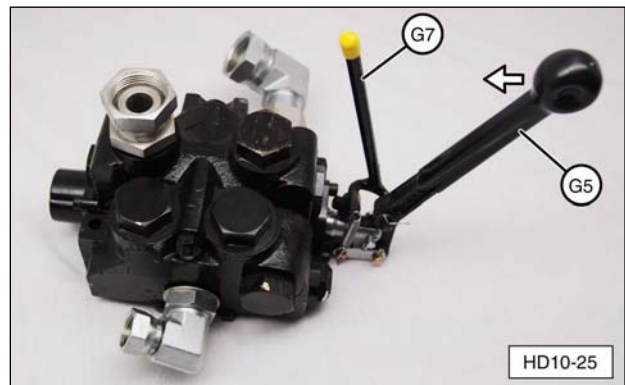

(G5) Main Hydraulic Control Valve Lever. (G7) Control Valve Safety Lever.

2. If main hydraulic control valve lever (G5) **CAN** move forward more than 1/4", the safety stop must be adjusted.

3. To adjust the safety stop, do the following:
 - a. Squeeze the control valve lever and the control valve safety lever together to expose the safety lever stop setscrew.
 - b. Insert a 1/8" Allen wrench and adjust the setscrew outward (counterclockwise) slightly. Remove the Allen wrench and repeat Step 1.



Adjust the Safety Stop Setscrew.

- c. If necessary, repeat Step 3a and Step 3b until the setscrew prevents more than 1/4" of forward movement of the control valve lever.

NOTE: Do not "over adjust" the setscrew. Make sure the setscrew easily falls into place behind the lip on the control valve when it is released quickly (1/8" gap at the setscrew).



Gap Between Setscrew and Valve Body.

Rubber Debris Guard

1. Locate rubber debris guard (A4), guard mounting strap bracket (A5), and bag containing hardware and caution tag (A6, A7, A8, and A9).

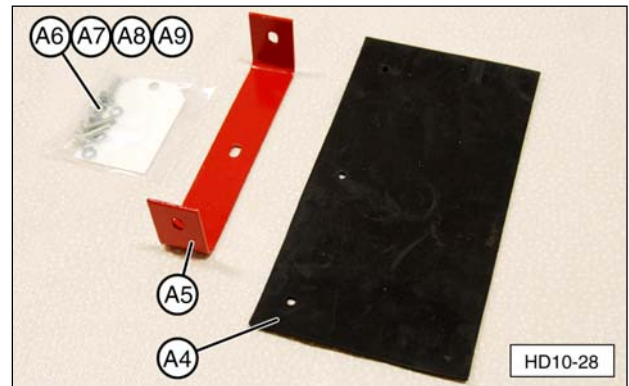

(A4) Rubber Debris Guard. (A5) Guard Mounting Strap Bracket. (A6) Caution Tag. (A7) Bolt. (A8) Lock Washer. (A9) Nut.

2. Attach rubber debris guard, mounting strap, and caution tag on drive ram (A1) with guard mounting bolts, lock washers, and nuts, as shown.

NOTE: To avoid damage to the rubber debris guard, do not over-tighten the mounting hardware.



(A1) Drive Ram.

Safety Arm

! WARNING



To avoid serious injury or death, the safety arm must be installed after the Post Driver has been mounted on a machine, or the freestanding Post Driver has been secured to prevent tipping.

1. Locate safety arm assembly parts and hardware.

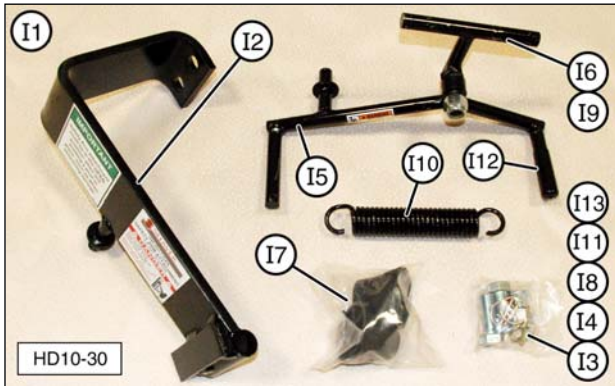

(I2) Safety Arm Frame. (I3) Frame Mounting Bolt.
(I4) Self Locking Nut. (I5) Swing Arm Handle.
(I6) Roller Bracket. (I7) Rollers. (I8) Roller Retainer Roll Pin. (I9) Roller Bracket Nut. (I10) Latch Spring.
(I11) Spring Retainer Flat Washer. (I12) Swing Arm Handle Cover. (I13) Lynch Pin.

2. Attach safety arm frame (I2) to outside of short channel bracket (D1 or D2) with two 3/4-10 x 2" frame mounting bolts (I3) and self locking nuts (I4), as shown. Tighten nuts securely.

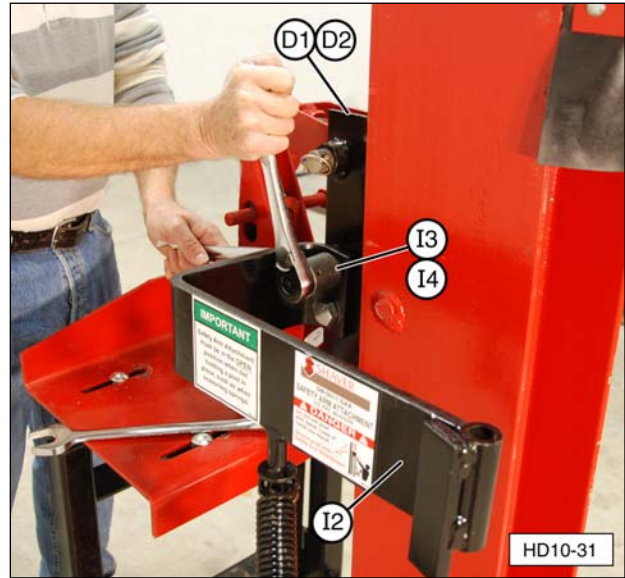

(D1) Manual Short Channel Bracket. (D2) Hydraulic Short Channel Bracket (not shown). (I2) Safety Arm Frame. (I3) Frame Mounting Bolt. (I4) Self Locking Nut.

3. Assemble rollers (I7) onto roller bracket (I6) and secure with two roller retainers roll pins (I8), as shown.

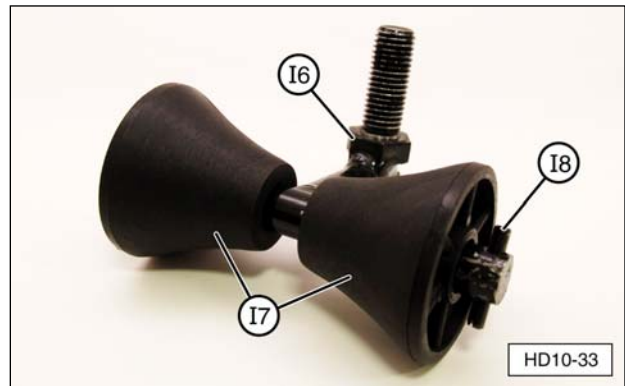

(I6) Roller Bracket. (I7) Roller. (I8) Roller Retainer Roll Pin.

4. Apply a light film of a good quality grease to the pivot shaft and attach roller bracket (I6) to swing arm handle (I5) with roller bracket nut (I9). Tighten nut until seated and then loosen 1/4 to 1/2 turn.

NOTE: Roller bracket (I6) must swivel freely on swing arm handle (I5).

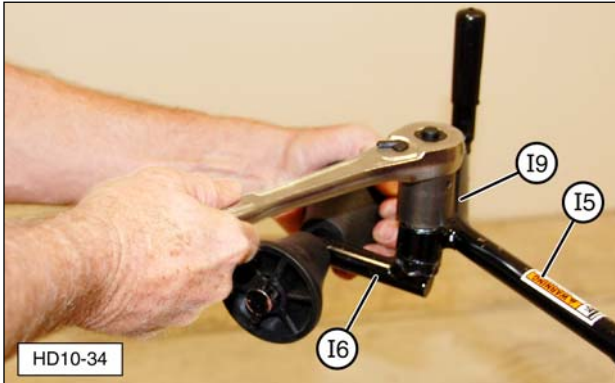

(I5) Swing Arm Handle. (I6) Roller Bracket. (I9) Roller Bracket Nut.

5. Attach one end of latch spring (I10) to swing arm handle (I5), as shown. Secure with spring retainer flat washer (I11) and Lynch pin (I13).



(I5) Swing Arm Handle. (I10) Latch Spring. (I11) Spring Retainer Flat Washer. (I13) Lynch Pin.

6. Install the swing arm assembly.
 - a. Apply a light film of a good quality grease to the pivot shaft on swing arm handle (I5).
 - b. Start the pivot shaft into the main bracket tube, as shown. Slide the open spring eye over the main bracket anchor rod.



NOTE: Swing arm handle (I5) will be below safety arm frame (I2) bracket stop at this point.

- c. Secure spring with flat washer (I11) and Lynch pin (I13).

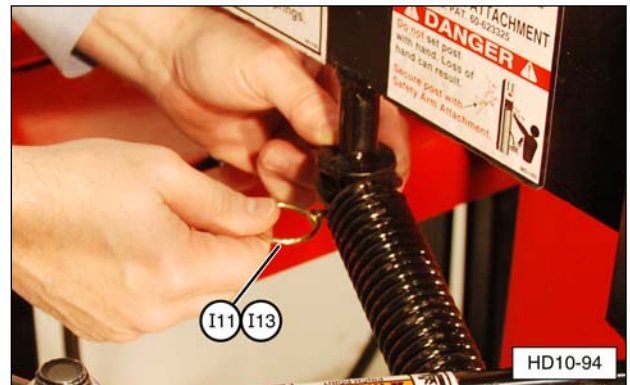

(I11) Flat Washer. (I13) Lynch Pin.

! WARNING



To avoid serious injury or death, the safety arm must be installed after the Post Driver has been mounted on a machine, or the freestanding Post Driver has been secured to prevent tipping.

7. Pull swing arm handle around toward the Post Driver I-beam until the swing arm clears (swings past) safety arm frame (I2) bracket stop.

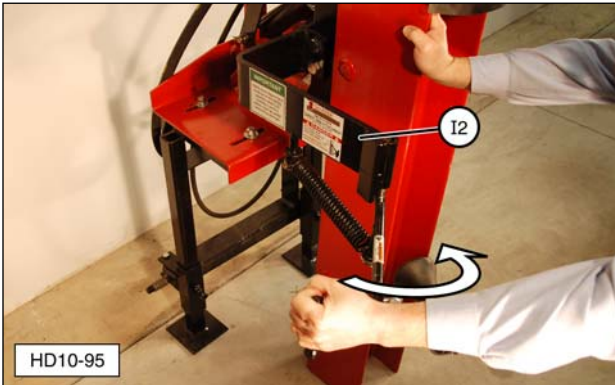

8. Tap swing arm shaft up through safety arm frame tube.

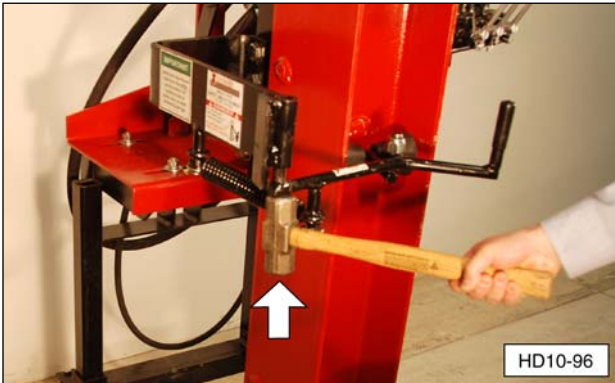

9. Install Lynch pin (I13) to secure the swing arm to the safety arm frame.

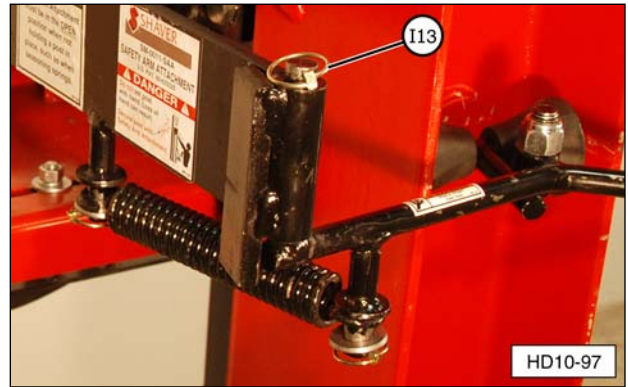

10. Verify the swing arm handle opens against safety arm frame (I2) stop bracket and closes against back wall of drive ram (A1) I-beam.

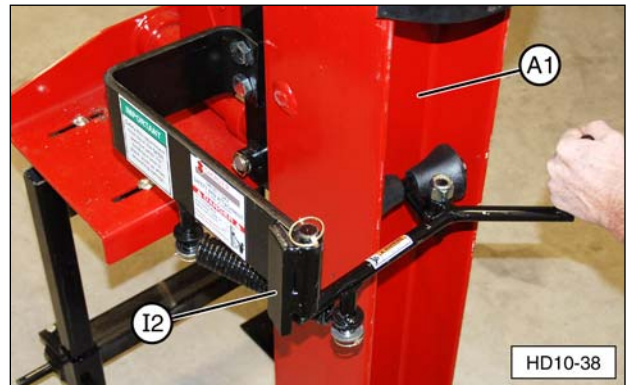

(A1) Drive Ram. (I2) Safety Arm Frame.

NOTE: When driving a fence post, the swing arm rollers must contact and hold the fence post in position, as shown.



Document Storage Tube



1. If desired, locate the document storage tube in a convenient location on the Post Driver. The photo below shows the tube mounted on the drive ram, but other locations are acceptable.

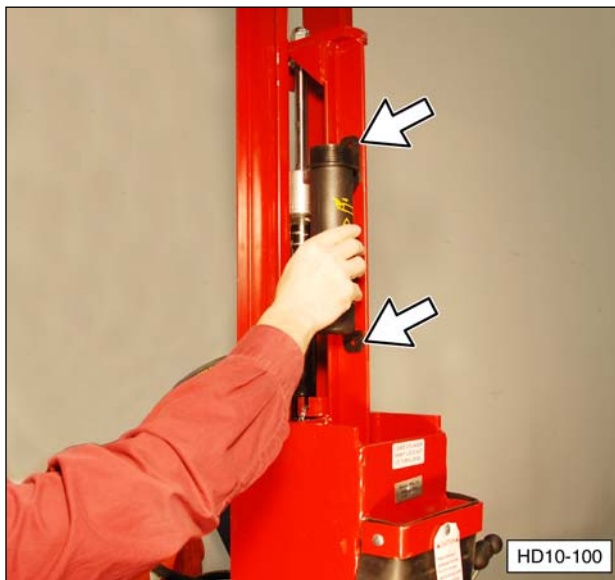

2. Mark the location of the two mounting holes using the storage tube as a guide.
3. Drill two 3/16" holes.
4. Attach the storage tube with the two pop rivets supplied inside the tube.

Post Driver Operation

Operational Safety Tips

1. Follow all safety information contained in this manual and refer to safety decals located on the Post Driver.
2. Personal safety equipment must be worn at all times during operation, i.e. safety glasses, steel toe shoes, hearing protection, etc.
3. Always stand 45 degrees to the right of the post while the Post Driver is in operation.
4. **Do not** remove any of the Post Driver safety equipment or safety labels.
5. All Post Driver safety equipment must be inspected, maintained, kept in working order, and used during Post Driver operation.
6. **Do not** place your hand(s) on top of the post when placing the post in the Post Driver or while the Post Driver is operating.
7. Leave the safety arm attachment open when not holding a post, except when transporting the Post Driver.
8. **Do not** remove the hydraulic control valve safety lever stop.
9. Never use the maximum force of the Post Driver until the post being driven is started into the ground and is straight.
10. Use caution when driving small diameter wood or steel posts. Maximum driving impact is not necessary.
11. Always be aware of the environment in which you are operating the Post Driver.
12. **Do not** operate the Post Driver on steep slopes, as this could cause a roll over.
13. Always check for underground utilities, i.e. wires, gas lines, waterlines, etc. Call your local utility companies for underground utility locations.
14. Use caution where large rocks or other objects could be hidden underground and not visible to the operator. The post could splinter and cause injury to the operator. If the post fails to drive into the ground after two or three strikes, move to another location.

15. **Do not** operate the Post Driver with the machine or power source unattended. The Post Driver requires two people for proper operation - one operating the Post Driver and one on the tractor.
16. Always engage the road lock pin in the drive ram lower hole before transporting and in the upper hole for storage.

Operating Instructions

Mounting

1. With the Post Driver positioned on a hard level surface, move the tractor or other power supply toward the Post Driver until the three-point hitch lines up.
2. Attach two lower, three-point hitch lift arms to Post Driver three-point hitch weldment (K1) hitch pins. Secure with lock pins (operator supplied).
3. Attach the three-point top link to removable pin (B8) Secure upper pin with Lynch pin (B9).

NOTE: Adjust the length of the machine's top link, as required, to correctly attach the Post Driver.

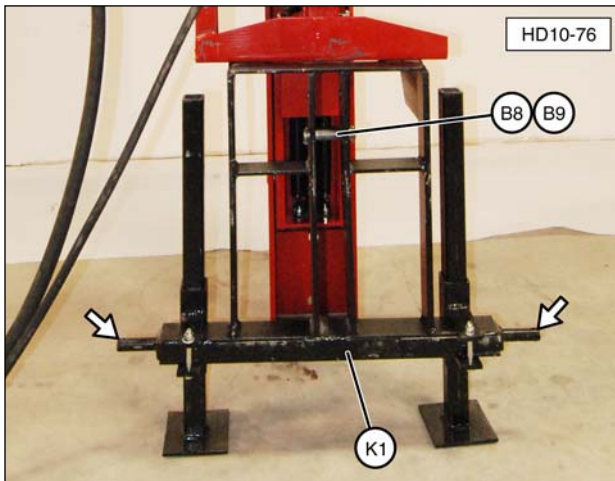

(K1) Three-Point Hitch Weldment. (B8) Top Link Pin. (B9) Lynch Pin.

NOTE: The HD-10 and HD-10-H Post Driver will fit tractors with Category II or Category III three-point hitches. Use bushings (operator supplied) on the hitch pins, if required, to correctly install the lift arms.

4. Attach hydraulic pressure supply hose (small diameter, G17) to the tractor pressure supply port. Attach hydraulic return hose (larger diameter, G20) to the tractor return port.

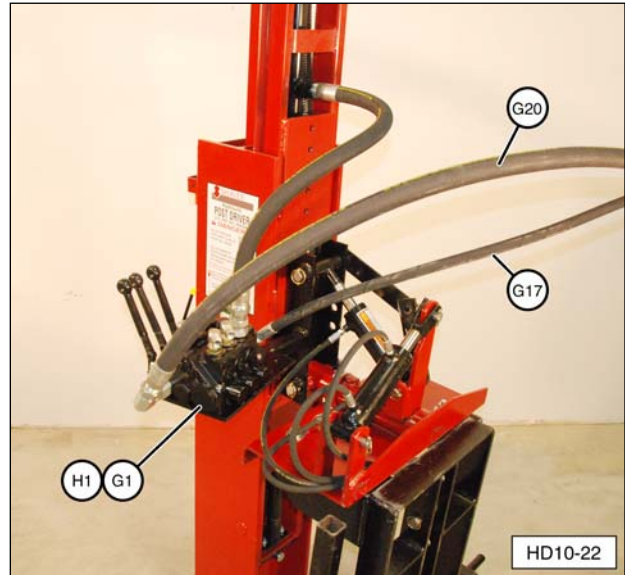

(G1 or H1) Control Valve. (G17) Hydraulic Pressure Supply Hose. (G20) Hydraulic Return Hose.

NOTE: The operator is responsible for installing quick-disconnect fittings (or other suitable fittings) on the Post Driver hoses. Make sure the fittings are compatible with the tractor hydraulic fittings.

5. If traveling more than 100 feet to drive the first post, remove road lock pin (B8). Raise drive ram (A1) and install the road lock pin in the lower "transport" position. The Post Driver can now be moved to the work site.

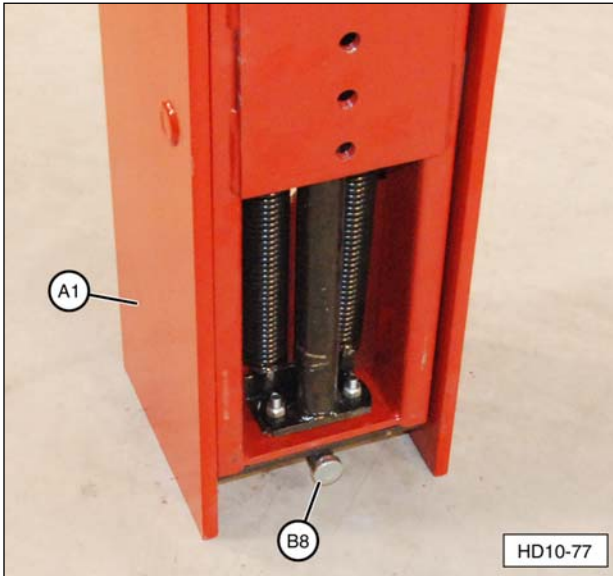

(A1) Drive Ram. (B8) Road Lock Pin (transport position).

Preparing to Drive a Post

IMPORTANT NOTICE

If operating on uneven ground, make sure the stabilizer legs firmly contact the ground at each new fence post location. If necessary, loosen the stabilizer leg lock bolts to readjust the stabilizer legs, as needed. Failure to do so can cause damage to the Post Driver components.

1. Loosen stabilizer leg lock bolts (K8) and raise up each stabilizer leg (K7). Tighten the lock bolts to support the stabilizer legs.

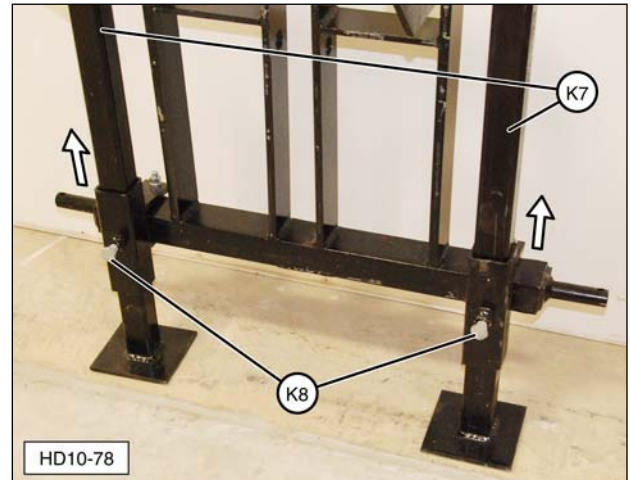

(K7) Stabilizer Leg. (K8) Lock Bolts.

2. Position the tractor or power source in place to drive the first fence post.
3. Set the brakes on the tractor or power supply. If the machine is equipped with an automatic transmission, the transmission must be in PARK.
4. Remove road lock pin (B8) and lower drive ram (A1) until it rests on main carriage channel lower rubber bumpers (B3) (store road lock pin in a secure location).

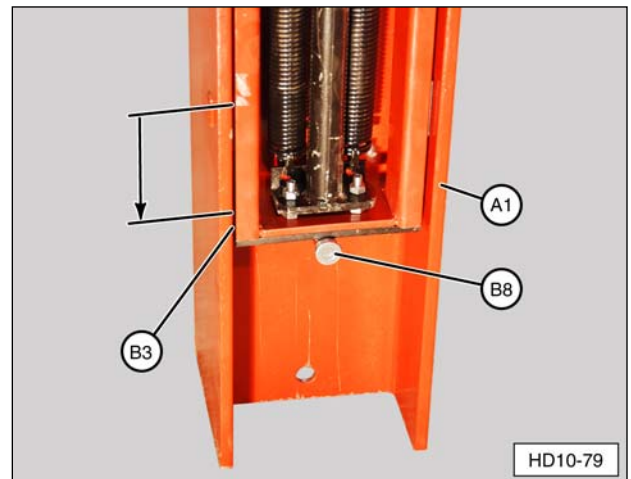

(A1) Drive Ram. (B3) Main Carriage Channel Lower Rubber Bumper. (B8) Road Lock Pin.

5. Lower Post Driver until drive ram (A1) firmly contacts the ground.
6. Continue to lower Post Driver main carriage channel (B1) an additional 1" (2.5 cm). This important step helps protect lower rubber bumpers (B3) from premature wear and/or damage.
7. Loosen stabilizer leg lock bolts and lower stabilizer legs until both feet firmly contact the ground. Tighten the stabilizer leg lock bolts.

Driving a Post

1. Lubricate four guide blocks (A2) with oil before each daily use and, if necessary, between post installations.

IMPORTANT NOTICE

Do not use grease on the guide blocks or in the main carriage channel. Grease will retain abrasive material, which will result in premature wear.



NOTE: The tractor or other power source must be capable of maintaining adequate hydraulic pressure (engine RPM) to smoothly operate (cycle) the Post Driver.

⚠ WARNING



To avoid personal injury or death, do not operate the Post Driver by yourself. Always have another person to control the machine or power source.

2. Squeeze safety lever (G7) and pull back main hydraulic control valve lever (G5) to raise drive ram (A1).

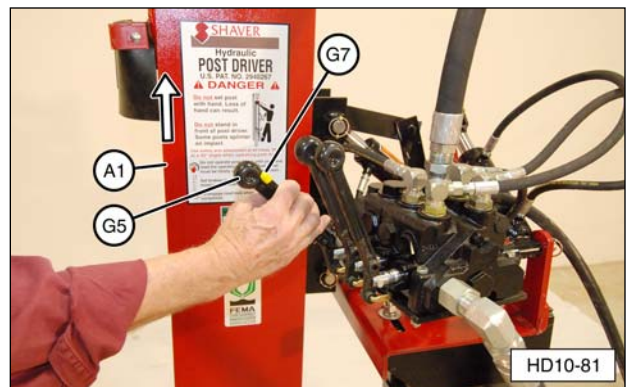

(A1) Drive Ram. (G5) Hydraulic Control Valve Lever.
(G7) Safety Lever.

IMPORTANT NOTICE

At the beginning of each day, use the main hydraulic control lever to cycle the drive ram up and down 10 to 15 times, without impact with a post or the ground, to “season” the drive ram return springs. Failure to follow this recommendation can cause damage to the springs.

- To drive the fence post straight, adjust the main carriage channel side-to-side and fore-and-aft using manual cranks (manual base plate) or second and third hydraulic control valve levers (hydraulic base plate).

IMPORTANT NOTICE

If the tilt cylinder hoses are attached differently than shown, the control of the drive ram will not be as described in this manual.

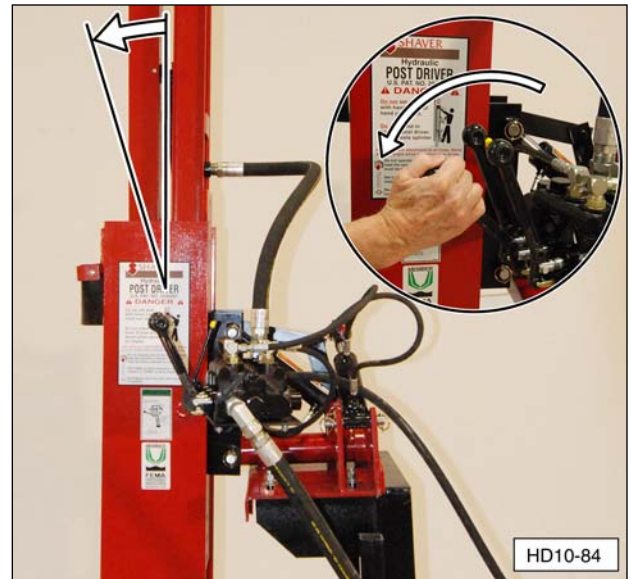

Tilt Top of Drive Ram Away From Tractor.

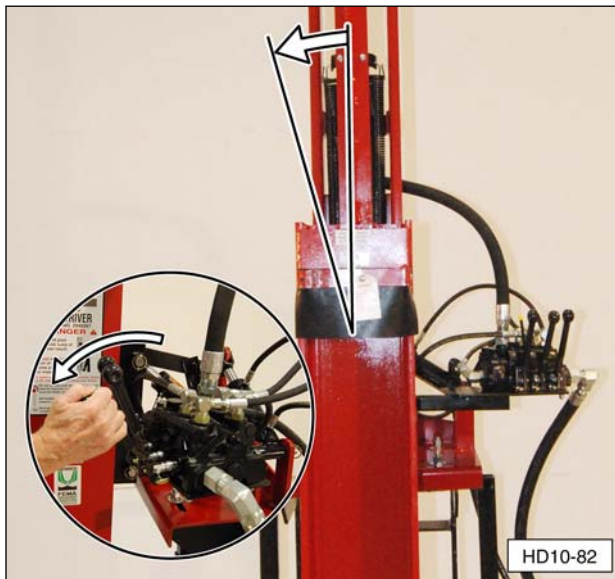

Tilt Top of Drive Ram Away From Operator.

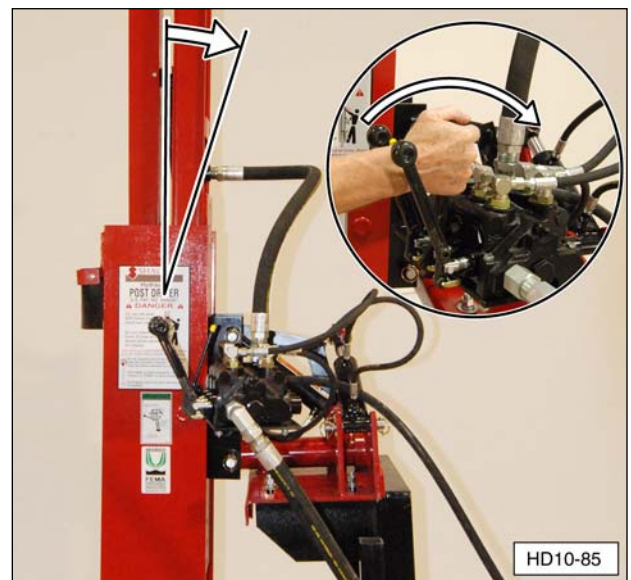

Tilt Top of Drive Ram Toward Tractor.

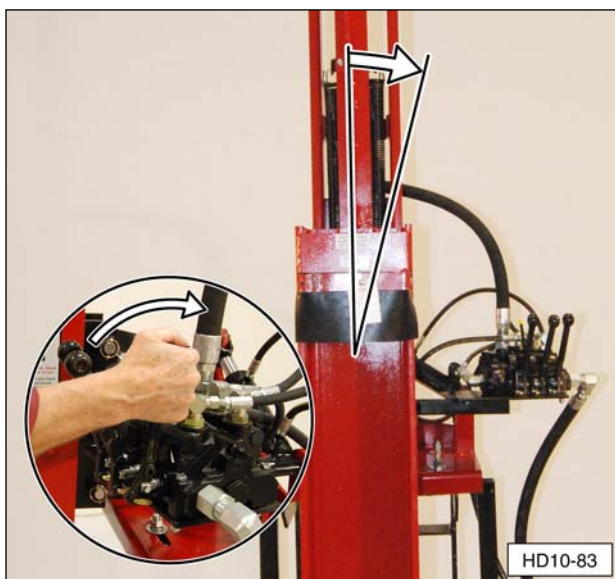

Tilt Top of Drive Ram Toward Operator.

! WARNING



Potential pinch points. Keep hands clear of Post Driver while operating. Never place hand(s) on top of a post when inserting it into the Post Driver. Always close the safety arm when driving the post.

4. With the drive ram in the raised position, place a fence post in the I-beam, under the drive ram plate.

NOTE: There should be a 1" to 2" gap between the top of the fence post and the bottom of the drive ram plate. The photo below shows the rubber debris guard raised up for photographic purposes. Never drive a fence post without the guard in place.

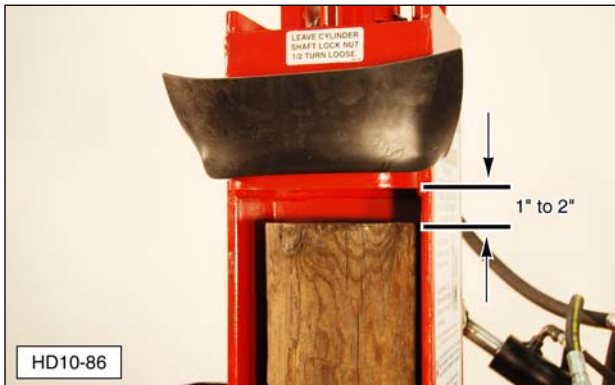

5. Close safety arm frame (I2) to secure the post (the adjustable roller assembly keeps tension on the post while it is being driven).

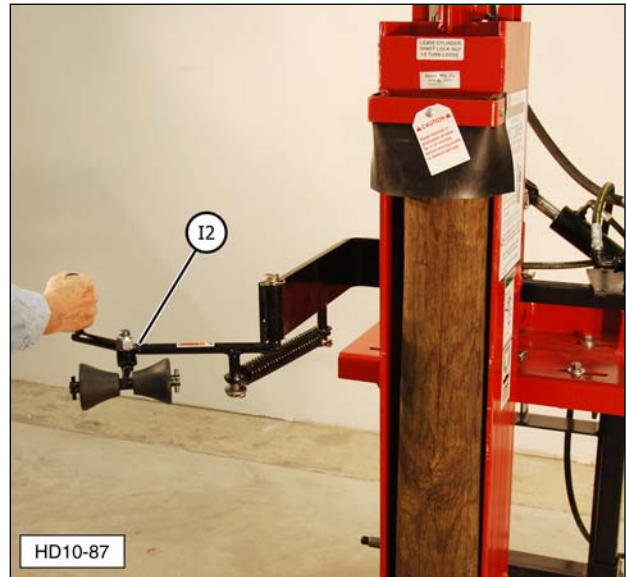

(I2) Safety Arm Frame.

6. **Do not** stand in front of the drive ram while operating the Post Driver. Stand at a 45 degree angle to the side of the Post Driver, in front of the hydraulic control valve.



3. Raise or lower the stabilizer legs to allow drive ram I-beam full contact with the ground. Make sure the Post Driver is stable.

NOTE: On units without stabilizer legs, store the unit against a post driven into the ground. Position the unit with the driving ram next to the post and secure with a chain wrapped securely around the post and Post Driver.

⚠ WARNING



On hydraulic tilt Post Drivers, to prevent the forward tilt cylinder from drifting, tighten the bolt and nut on the cylinder stop bracket. Failure to tighten this bolt and nut could allow the dismantled Post Driver to fall over, causing serious injury or even death.

4. On hydraulic tilt Post Drivers, tighten the nut on cylinder stop bracket bolt (F11) to prevent the cylinder from drifting and causing an unstable condition with the Post Driver.

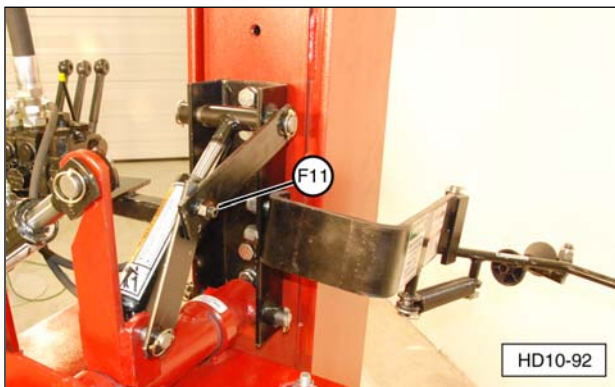

(F11) Cylinder Stop Bolt.

5. Make sure all pressure is released (zero pressure) from the Post Driver hydraulic system. Disconnect hydraulic pressure supply hose (G17) from the tractor. Disconnect hydraulic return hose (G20) from the tractor.

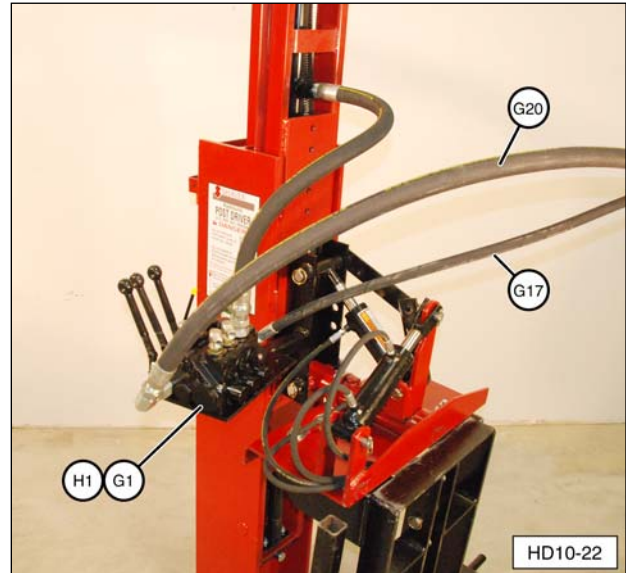

(G17) Hydraulic Pressure Supply Hose. (G20) Hydraulic Return Hose. (G1 or H1) Control Valve.

6. Remove top link pin (B8) from weldment (K1) and disconnect three-point hitch top link. Disconnect the two lower lift arms from the three-point hitch weldment to separate the tractor three-point hitch from the Post Driver.
7. Carefully move the tractor or power source away from the Post Driver.

Failure to tighten this bolt could allow the Post Driver to fall over, causing serious injury or even death.

Troubleshooting

NOTE: Refer to the Service Parts section of this manual for a photo and description of all the parts.

Problem: Drive ram (A1) will not move or slide freely on main carriage channel (B1).

Possible Cause/Solution(s):

1. Guide blocks (A2) lack lubricant. Lubricate with clean engine oil.
2. Guide blocks (A2) installed incorrectly. Refer to Service Information section assembly procedures for correct orientation.
3. Incorrect clearance between main carriage channel (B1) and drive ram (A1) I-beam. Refer to Service Information section for clearance specifications.
4. Hydraulic drive cylinder assembly (C1) is not parallel to main carriage channel (B1). Refer to Service Information section, hydraulic drive cylinder installation, and parallelism adjustment.
5. Main carriage channel (B1) or drive ram (A1) is bent or damaged. Discontinue use and order replacement parts.

Problem: Poor performance, low or no impact, hydraulic drive cylinder will not extend.

Possible Cause/Solution(s):

1. Weak or broken drive ram springs (C14).
2. Broken lower spring bracket (C13).
3. Bent or damaged hydraulic drive cylinder assembly (C1).
4. Main carriage channel (B1) is binding.
5. Restricted or plugged hydraulic hose(s) (G15, G17, G20).
6. Low or no hydraulic pressure or flow from the machine or power source.

Problem: Rubber bumpers (B3) have premature or excessive damage.

Possible Cause/Solution(s):

1. Post Driver is not properly adjusted prior to operation and drive ram guide blocks (A2) are contacting rubber bumpers (B3).

Storage

For best results, always store equipment in a dry, protected location. Leaving equipment unprotected will shorten the service life of the implement.

1. Before storing, remove debris and clean the entire unit with compressed air or pressure washer.
2. Inspect the Shaver Post Driver. Replace any worn or damaged parts before using the Post Driver again.
 - Check all bolted connections. Ensure that fasteners are tight, and all pins are secured in place.
 - Inspect frame for structural fractures.
 - Make sure all warning decals are in place and legible.
 - Make sure rubber debris guard is in place and in good condition.
 - Check hydraulic cylinder(s) for signs of seal damage or excessive wear.
 - Inspect all hydraulic hoses and fittings for leaks or signs of wear.
3. After cleaning, lightly lubricate guide blocks with clean engine oil. Do not apply grease, as this will retain grit and cause excessive wear.
4. Clean and lubricate hydraulic control valve safety stop linkage. Make sure return spring and cotter pins are in good condition.
5. Apply a light coating of clean grease to all exposed hydraulic cylinder shafts to help prevent rust.

Service Procedures

WARNING



To avoid personal injury or death, carefully read and understand all instructions before attempting to assemble and/or operate the Post Driver. Do not operate or work on equipment unless you read and understand the instructions and warnings in this and all other applicable manuals. Contact Shaver Manufacturing Company if any of the instructions provided are unclear or not understood. Proper care is your responsibility. Always follow all State and Federal health and safety laws and/or local regulations.



To help prevent personal injury, protective equipment must be worn during Post Driver assembly, operation, and maintenance. Personal protective equipment should include, but not be limited to, safety glasses, hearing protection, protective gloves, and steel toe footwear.



Before making any adjustments on the Post Driver, ensure that all hydraulic levers are in the neutral position. Always shut off the machine, set parking brake, and remove key before performing any service.



Personal injury can result from slips or falls. DO NOT leave tools or parts laying around the work area, and clean up all spilled fluids immediately.

NOTE: Disassembly, assembly, and/or associated repairs must be performed with the main carriage channel and drive ram in a horizontal position, such as on a suitable pallet, or heavy-duty support stands.

Refer to Dismounting Post Driver from Machine/Power Source section for steps to remove Post Driver from a tractor or other power source.

Three-Point Hitch/Post Driver Disassembly

1. Secure the Post Driver upright [main carriage channel (B1) and drive ram (A1) assembly] to an appropriate overhead lifting device to prevent tipping.
 2. Disconnect drive cylinder to valve hose (G15) and drain fluid into a suitable container.
 3. On hydraulic base plate Post Drivers, tighten cylinder stop bolt (F11). Disconnect four tilt cylinder hoses (H5) from hydraulic control valve (H1), and drain fluid into a suitable container.
 4. Remove Lynch pins (D7) and two channel mounting pins (D6) that connect the base plate to the Post Driver upright (applies to manual or hydraulic models).
- NOTE:** If necessary, lubricate channel mounting pins with penetrating oil to assist pin removal.
5. With assistance, carefully move the three-point hitch weldment/base plate assembly away from the Post Driver upright. Store weldment/base plate assembly in a safe location.
 6. The upright assembly is heavy. Use an appropriate lifting device to position the Post Driver assembly horizontally, on suitable stands, pallet, or blocks on the ground.



Main Carriage Channel Disassembly

NOTE: Be prepared to collect any hydraulic fluid that drains from the cylinder into a suitable container.

- 1a. Remove road lock pin (B8).
- 1b. Slide the main carriage channel up as far as possible, to relieve tension on the springs.

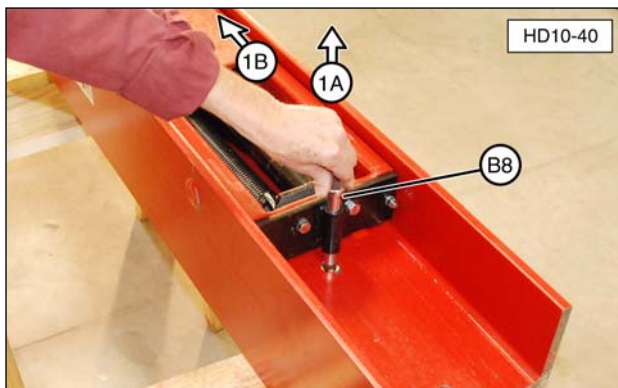

(B8) Road Lock Pin.

2. Loosen, but **do not remove**, two self-locking nuts (C12) that attach drive cylinder (C2) and lower spring bracket (C13) to main carriage channel (B1).

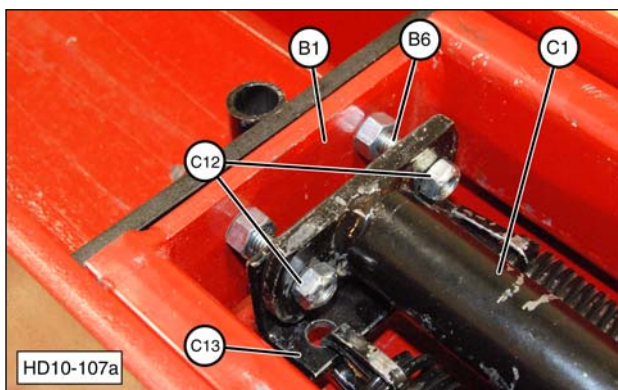

(B1) Main Carriage Channel. (C1) Drive Cylinder.
(C12) Self-Locking Nut. (C13) Lower Spring Bracket.

3. Connect retaining strap (T19) to both upper spring eyes, with the strap positioned around the top of the drive ram lift yoke bar, as shown.



(T19) Retaining Strap.

4. Use retaining strap to pull springs (C14) and then remove upper spring bracket (A11) hardware. Carefully loosen the retaining strap to release tension from the springs.

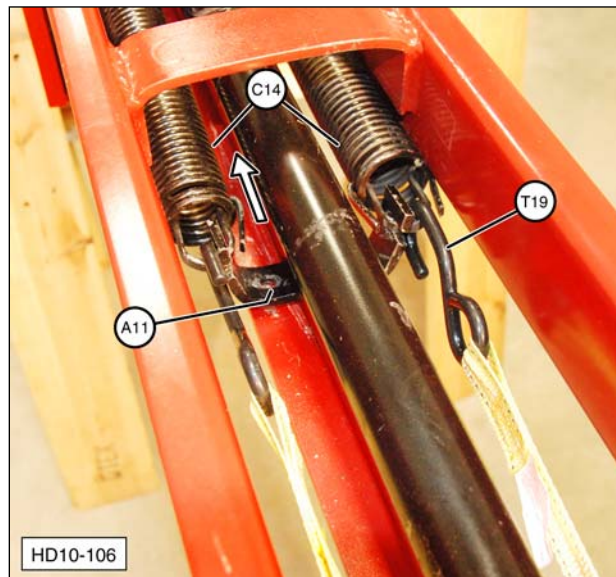

(A11) Upper Spring Bracket. (C14) Return Springs.
(T19) Retaining Strap.

5. Remove the retaining strap and the upper spring bracket.
6. Remove upper cylinder rod self-locking nut (C4) and lock washer (C16) from drive cylinder piston (C3).

NOTE: Do not reuse self-locking nut (C4). Replace with a new self-locking nut.

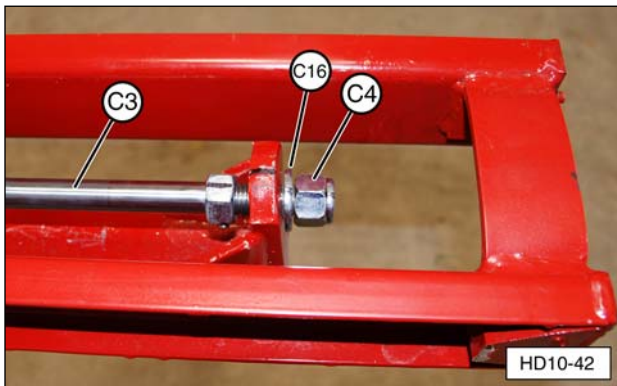

(C3) Drive Cylinder Piston. (C4) Self-Locking Nut. (C16) Lock Washer.

7. Remove two self-locking nuts (C12) which were loosened in Step 2. Remove drive cylinder (C1) and lower spring bracket (C13) from road lock bracket bolts (B6)
8. Remove two road lock bracket nuts (B7) and remove road lock bracket (B2) from main carriage channel (B1).

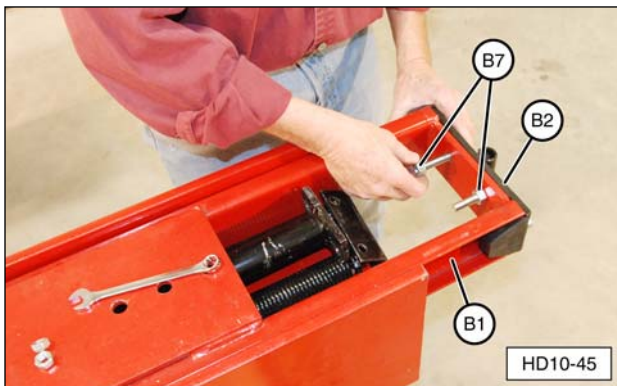

(B1) Main Carriage Channel. (B2) Road Lock Bracket. (B7) Road Lock Bracket Nuts.

- 9a. Slide the main carriage channel downward.
- 9b. Remove the springs from the bottom of the Post Driver between the drive ram and the main carriage channel, as shown.

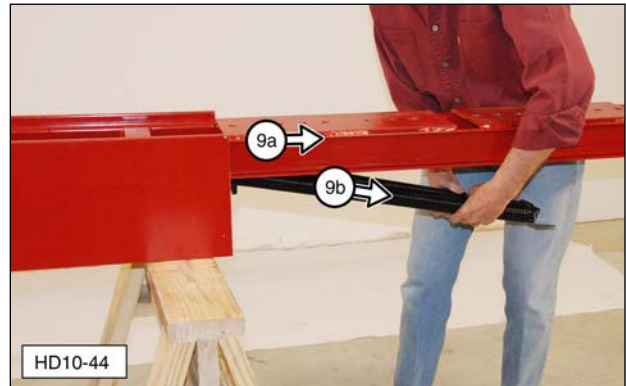

10. Remove drive cylinder (C1) by sliding it out the top of drive ram assembly (A1).

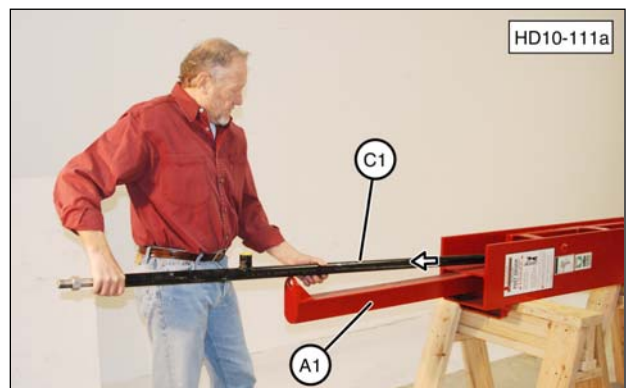

(A1) Drive Ram Assembly. (C1) Drive Cylinder.

11. Get assistance to remove main carriage channel (B1) by sliding it out the top of drive ram (A1).

NOTE: For information on cylinder service, refer to Drive Cylinder Seal Replacement section.

12. Remove guide blocks (A2) and shims (A3) from the pins inside the drive ram I-beam.

IMPORTANT NOTICE

Note the number and thickness of the shims, and the location of each shim pack removed. This information is needed for correct drive ram reassembly.

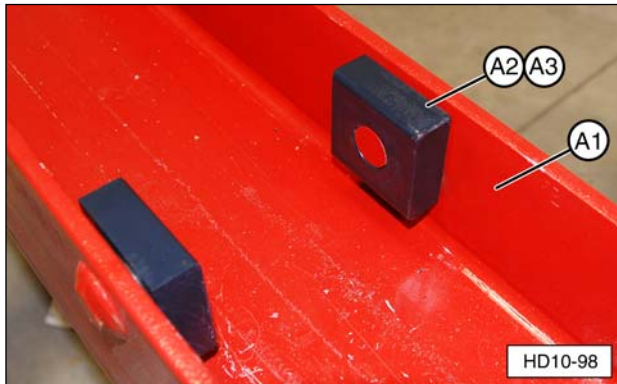

(A1) Drive Ram. (A2) Guide Blocks. (A3) Shims (behind guide blocks).

13. Inspect all components for wear and/or damage. Replace any worn or damaged parts before using the Post Driver again.

- Drive ram (A1) I-beam.
- Contact points on guide blocks (A2).
- Main carriage channel.
- Road lock bracket, rubber bumpers, and hardware.
- Springs, and upper and lower spring mounting brackets.

Drive Cylinder Seal Replacement

1. Remove drive ram cylinder assembly (C1) from the Post Driver, as outlined in the disassembly instructions.

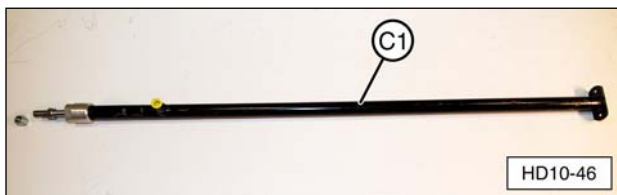

(C1) Drive Ram Cylinder Assembly.

2. Be prepared to collect any hydraulic fluid that drains from the cylinder into a suitable container. Unscrew cylinder cap (C7) and remove cylinder piston rod (C3) from the cylinder housing.

NOTE: Care must be taken during removal to prevent scoring of cylinder piston rod (C3) or inside of cylinder tube (C2).

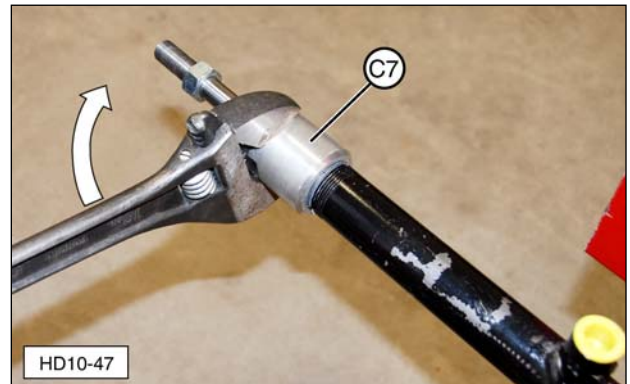

(C2) Cylinder Tube. (C3) Cylinder Piston Rod.
(C7) Cylinder Cap.

3. Inspect the threads on the outside of drive cylinder (C2) tube and inside of cylinder cap (C7). Repair or replace components with damaged threads.

- Remove self-locking piston guide nut (C11) and piston rod guide (C10), using a 1-1/4" wrench to hold the piston rod guide while removing the piston guide nut. Discard the self-locking nut and replace with new.

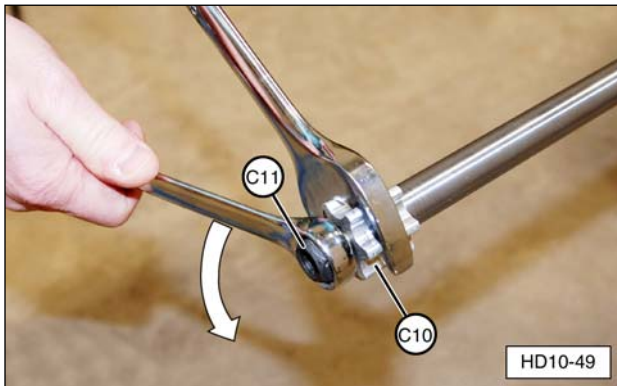

(C10) Piston Rod Guide. (C11) Self-Locking Piston Guide Nut.

- Place cylinder cap (C7) and cylinder cap seal (C9) in hot (120°F) water for ten minutes. Soaking the cap and seal will make the seal more pliable and easier to remove.

⚠ WARNING



The cylinder cap and seal will be hot. To avoid personal injury, wear protective gloves and take precautions to avoid direct contact with hot surfaces.

- Wear gloves and use a sturdy seal pick to remove cylinder cap seal (C9) from cylinder cap (C7).

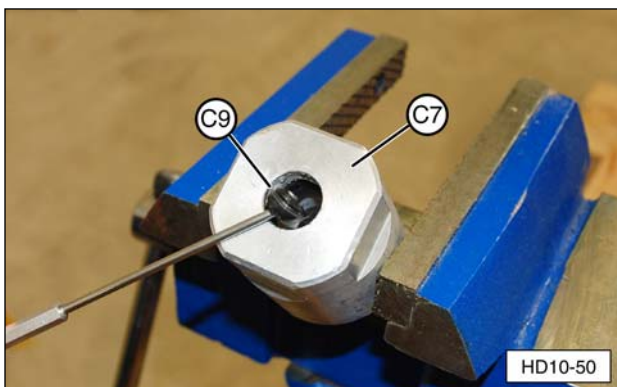

(C7) Cylinder Cap. (C9) Cylinder Cap Seal.

- Clean the seal groove in the cylinder cap and place the new seal in hot (120°F) water for ten minutes.
- Once the seal is pliable, squeeze the new seal together making a banana shape. Place one end of the seal into the cylinder cap seal groove. Continue to push the seal into the seal groove, holding the seal in the groove from the bottom with one finger, while continuing to push the seal down from the top until the seal snaps in place.

IMPORTANT NOTICE

Care must be taken not to damage the new seal while installing it. Do not use a sharp tool, such as a screwdriver, to push the seal into place. A suitable diameter impact socket with rounded edges can be useful in pushing the seal into the cap groove.

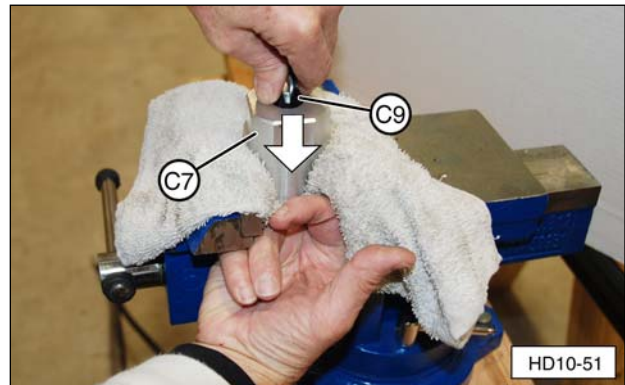

(C7) Cylinder Cap. (C9) Cylinder Cap Seal.

- Once cylinder cap seal (C9) is in the groove, double check for correct orientation. The sharp edge of the seal must be down (towards the threads inside the cap).
- Lubricate the seal with clean hydraulic fluid and slide the cap onto cylinder piston rod (C3) from the **bottom**.

IMPORTANT NOTICE

Do not slide the cylinder rod cap over the top of the drive cylinder rod. The threads will damage the new cylinder rod cap seal.

11. Install piston guide (C10) and new self-locking piston guide nut (C11), using a 1-1/4" wrench to hold the piston guide while installing the piston guide nut. Do not over-tighten the self-locking nut. Piston guide (C10) must be able to rotate on cylinder piston rod (C3).
12. Install cylinder piston rod (C3) assembly into drive cylinder tube (C2).

NOTE: Care must be taken during installation to prevent scoring of cylinder piston rod (C3) or the inside of drive ram cylinder tube (C2).

13. Apply paste-type thread sealant (T12) on drive cylinder tube (C2) external threads and install cylinder cap assembly (C7). Tighten cap securely.

IMPORTANT NOTICE

Hydraulic system fittings that require a thread sealant must be installed with a paste-type sealer only. Do not use a tape-type sealer, such as Teflon Tape, as this can contaminate the system and voids the valve warranty.

14. To install drive cylinder assembly (C1) in the Post Driver, follow the instructions in the Main Carriage Channel Assembly section.

Main Carriage Channel Assembly

1. Install guide block shims (A3) and guide blocks (A2) on the pins inside the drive ram I-beam. Make sure the shims are installed in their original locations.

NOTE: Chamfer (rounded edges) on guide blocks must be positioned horizontally to match the chamfer on the inside of the main carriage channel frame.

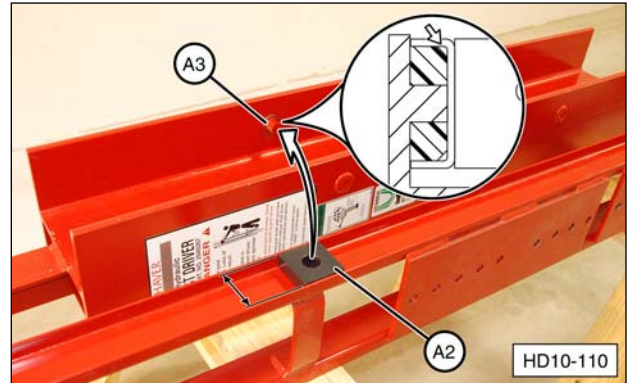

(A2) Guide Blocks. (A3) Guide Block Shims.

2. Lubricate the guide blocks with clean oil to reduce friction. Get assistance to slide main carriage channel (B1) over guide blocks (A2) from the top of the drive ram.

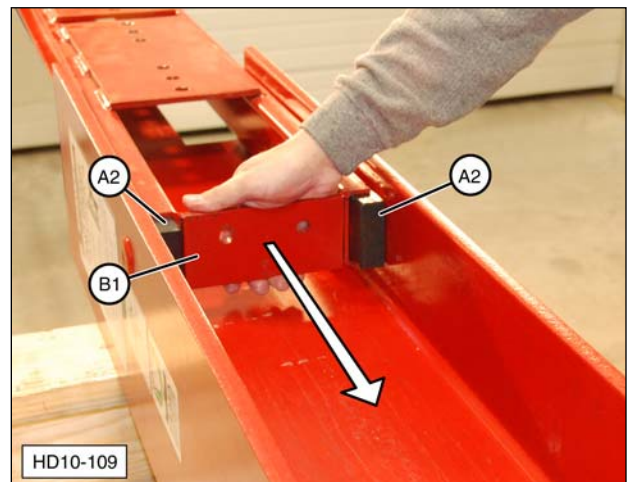

(A2) Guide Blocks. (B1) Main Carriage Channel.

3. The main carriage channel should slide back and forth freely.
4. With the drive ram assembly horizontal, check the up and down movement of the main carriage channel in the drive ram I-beam. Up and down movement should not be less than 1/4" or more than 1/2".
5. Install drive cylinder (C1) in drive ram assembly (A1) from the top (upper end).

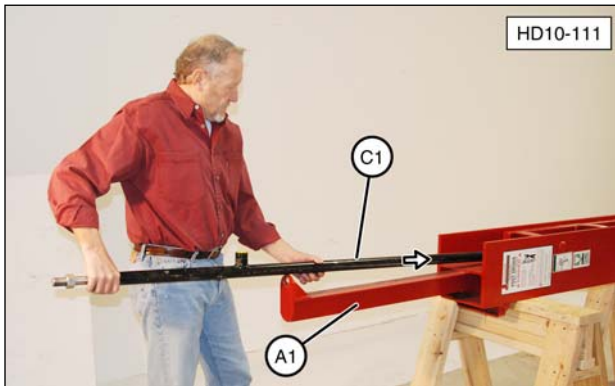

(A1) Drive Ram. (C1) Drive Cylinder.

NOTE: Hydraulic drive ram cylinder (C1) must be inserted in main carriage channel (B1) before springs (C14) are inserted. Position the cylinder laying loose inside the main carriage channel.

6. Install springs (C14) from the bottom of the Post Driver between drive ram (A1) I-beam and main carriage channel (B1), and slide into position.

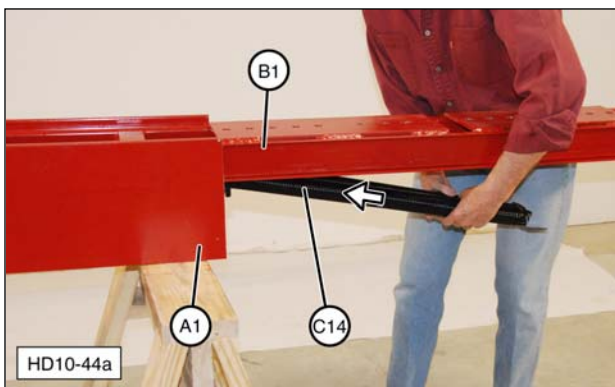

(A1) Drive Ram. (B1) Main Carriage Channel. (C14) Springs.

7. If removed, install two rubber bumpers (B3) on road lock bracket (B2). Install the road lock bracket on main carriage channel (B1) with bolts (B6) and road lock bracket nuts (B7). Leave nuts slightly loose.

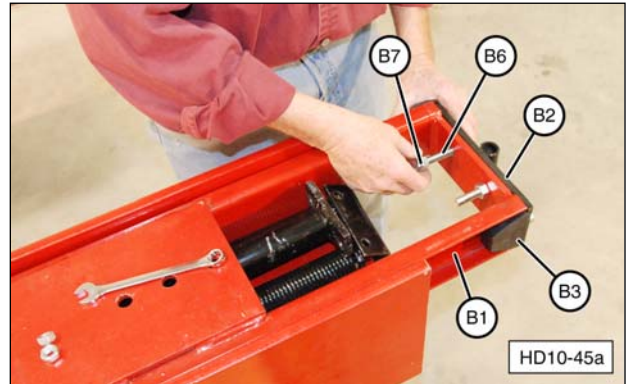

(B1) Main Carriage Channel. (B2) Road Lock Bracket. (B3) Rubber Bumper. (B6) Bolts. (B7) Road Lock Bracket Nuts.

8. Slide main carriage channel (B1) up (forward) and install lower spring bracket (C13) and drive cylinder assembly (C1) onto road lock bracket bolts (B6). Thread two new self-locking nuts (C12) onto bolts. Install nuts just enough to fully engage threads, as shown.

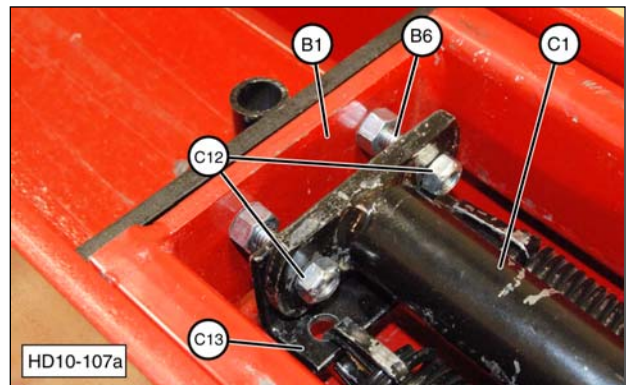

(B1) Main Carriage Channel. (B6) Road Lock Bracket Bolts. (C1) Drive Cylinder Assembly. (C12) Self-locking Nuts. (C13) Lower Spring Bracket.

9. Attach drive cylinder piston rod (C3) to the top of the drive ram I-beam using new lock washer (C16) and new self-locking nut (C4). Tighten the nut just enough to fully engage the threads.

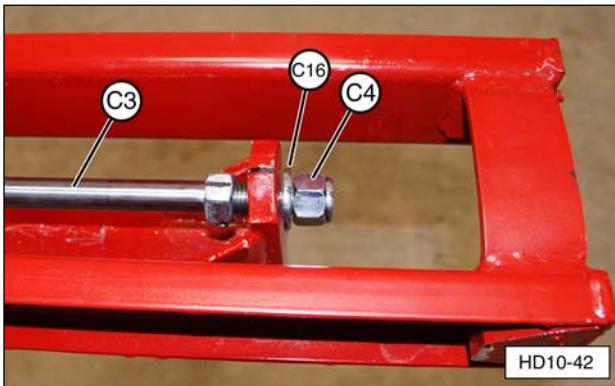

(C3) Drive Cylinder Piston Rod. (C4) Self-Locking Nut. (C16) Lock Washer.

10. Attach springs (C14) to upper spring bracket (A11). Hook retaining strap (T19) to spring clips, as shown.

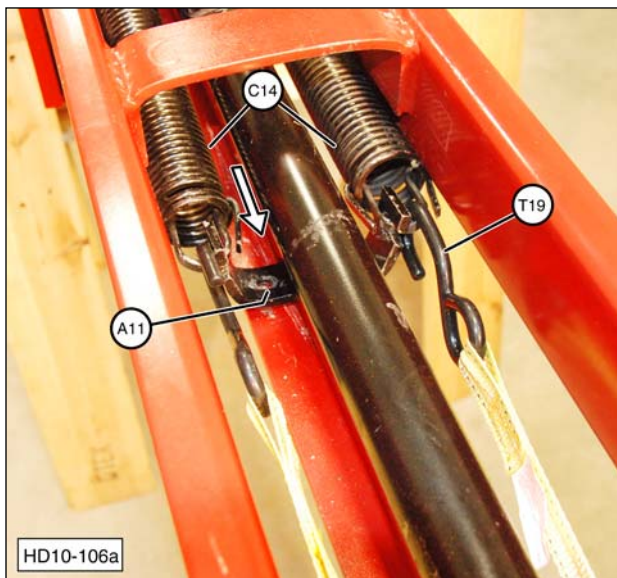

(A11) Upper Spring Bracket. (C14) Springs. (T19) Retaining Strap.

11. Install the upper spring bracket on the drive ram assembly.
 - a. Route retaining strap around top of drive ram lift yoke bar, as shown.

- b. Use the retaining strap to pull (stretch) the springs just enough to align holes in upper spring bracket and drive ram assembly.
- c. Install upper spring bracket hardware (C8) and tighten securely.
- d. Carefully release tension on the retaining strap and remove it from the Post Driver.

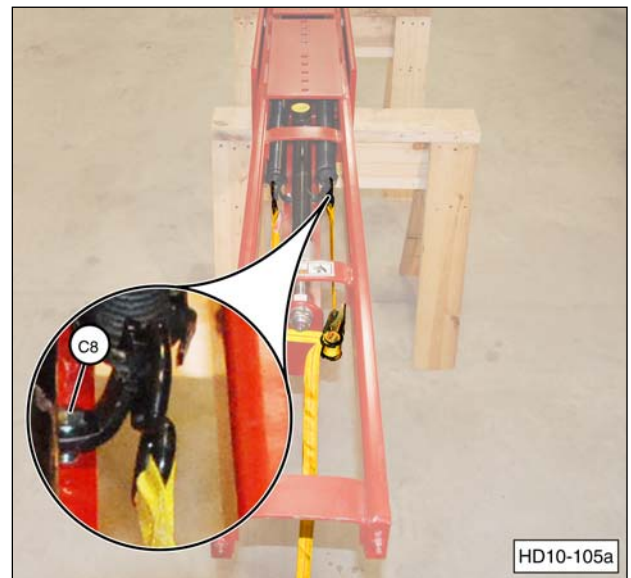

(C8) Upper Spring Bracket Bolts, Washers, and Nuts.

12. Align the drive ram cylinder.

- a. Hold the lower nut with a 1-1/8" wrench and tighten self-locking nut (C4) using a 1-1/16" wrench. Then loosen the self-locking nut 1/2 turn (180 degrees).

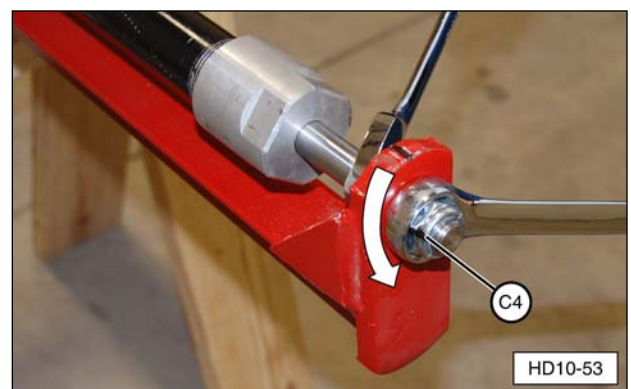

(C4) Self-locking Nut.

- b. Completely tighten road lock bracket nuts (B7) that were left loose in Step 7.
- c. Completely tighten self-locking nuts (C12) that were left loose in Step 8. Tighten each nut slightly, in turn, to align the drive cylinder inside the main carriage channel.

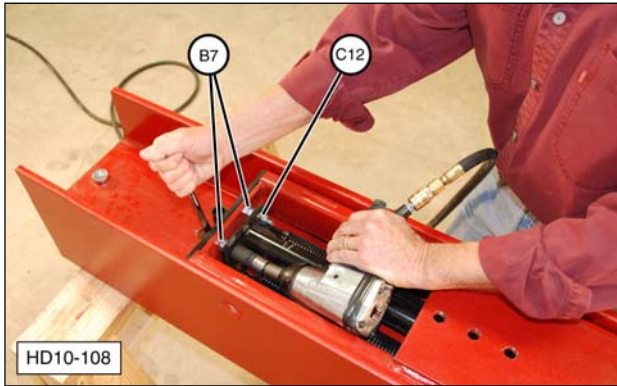

(B7) Road Lock Bracket Nuts. (C12) Self-locking Nuts.

- 13. Pull main carriage channel (B1) down and install road lock pin (B8) and Lynch pin (B9) in lower hole in drive ram (A1).
- 14. To avoid binding, the drive cylinder and rod must be parallel to the sides of the main carriage channel. If necessary, make the following adjustments:
 - a. Make sure the top drive ram cylinder self-locking nut is loosened 1/2 turn.
 - b. Loosen lower drive ram cylinder self-locking nuts (C12).
 - c. Tighten or loosen each nut slightly, in turn, to align the drive cylinder inside the main carriage channel.

NOTE: Self-locking nuts (C12) do not have to be completely tightened against the lower spring bracket.

Forward and Side Tilt Cylinder Maintenance

Cylinder Disassembly

WARNING



Removing tilt cylinder(s) from the assembled Post Driver can cause an unstable condition. To avoid personal injury or death, make sure the drive ram is stable and fully supported by other means before removing the tilt cylinders for service.

1. If removing cylinder(s) from the assembled Post Driver, make sure the drive ram is fully supported by other means, such as a suitable overhead lifting device, before disconnecting the tilt cylinders.
2. Disconnect the tilt cylinder hydraulic hoses from the hydraulic control valve. Plug the hoses and control valve fittings to prevent dirt from entering the hydraulic system.

NOTE: Be prepared to collect any hydraulic fluid that drains from the cylinder and hoses into a suitable container.

3. Clean the outside of tilt cylinders (F3, F4). Remove the tilt cylinders from the base plate by removing the mounting pins.
4. Inspect the tilt cylinder mounting points. Replace any worn or damaged components.

- Carefully clamp tilt cylinder (F3 or F4) mounting tube in a vise. Completely compress internal cylinder cap snap ring (F14) and pull cylinder rod assembly (F16 or F17) out of tilt cylinder tube (F21 or F27).

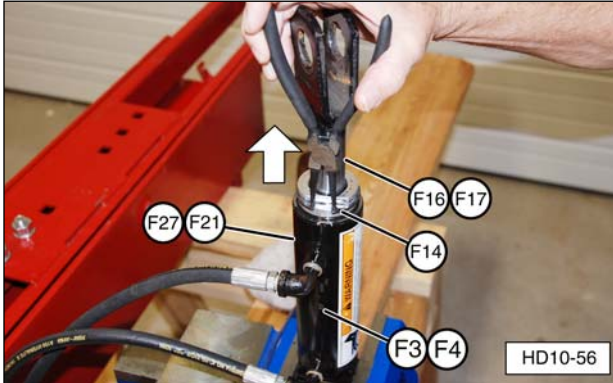

(F3, F4) Cylinder Assembly (forward or side tilt).
 (F14) Cylinder Cap Snap Ring. (F16, F17) Cylinder Rod Assembly (forward or side tilt). (F21, F27) Cylinder Tube (forward or side tilt).

- Disassemble cylinder rod (F16, F17) by removing cylinder rod nut (F20), piston (F19), piston to cylinder rod seal (F18), and cylinder cap (F15) from the cylinder rod.

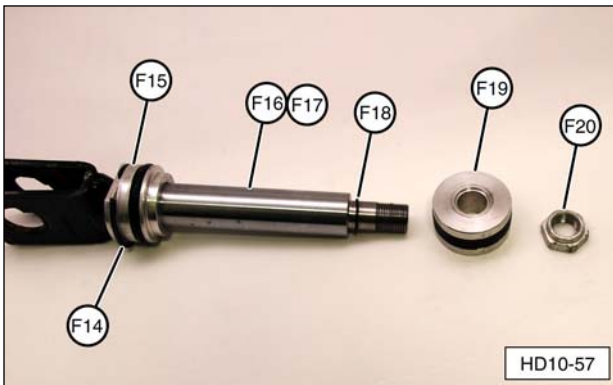

(F14) Snap Ring. (F15) Cylinder Cap.
 (F16 or F17) Cylinder Rod. (F18) Cylinder Rod Seal.
 (F19) Piston. (F20) Cylinder Rod Nut.

- Inspect the cylinder rod sealing surface for any dents, bends, nicks, pitting, scratches, scoring, or rust. Replace any worn or damaged components.

- Use a sturdy seal pick to remove the seals from the cylinder piston and discard. Clean and inspect the piston and replace if worn or damaged.
- Clean the inside of the tilt cylinder tube and inspect for scratches with raised (above the surface level) edges, wear, rust, cracks, and pitting. Replace any worn or damaged tube.
- Use a sturdy seal pick to remove the seals from the cylinder cap and discard. Clean and inspect the cap and replace if worn or damaged.

Cylinder Assembly

- Make sure all tilt cylinder components are clean and free of rust.
- Lubricate the new seals with clean hydraulic fluid.
- Install new internal O-ring seal (F23) and lip seal (F24) (raised lip up) inside the cylinder cap. Install new O-ring seal (F22) in the O.D. groove. Install new snap ring (F14), not shown, in the top “cut-a-way” groove.

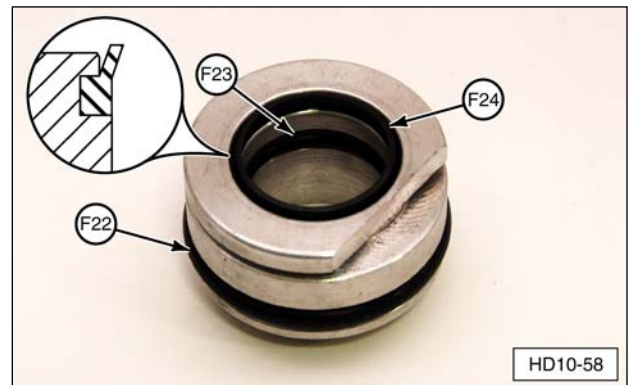

(F22) External O-ring Seal. (F23) Internal O-ring Seal.
 (F24) Internal Lip Seal.

4. Install new scraper seal (F25) in the cylinder piston groove, followed by O-ring seal (F26), and the second scraper seal (F25). Rounded (concave) surface of each scraper seal (F25) must face (contact) larger O-ring seal (F26).

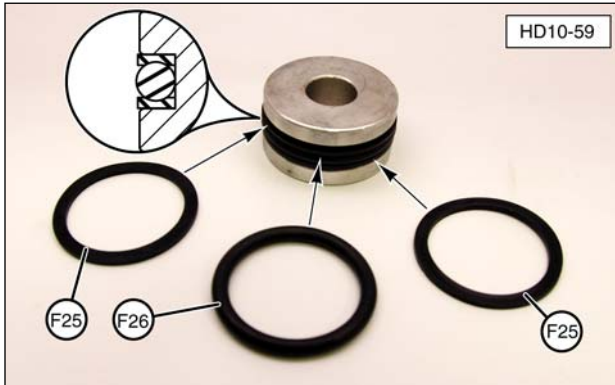

(F25) Scraper Seal. (F26) O-ring Seal.

5. Install new O-ring seal (F18) on the threaded end of cylinder rod (F16 or F17).
6. Lubricate the ID of cylinder cap (F15) with clean hydraulic oil and install the cap onto cylinder rod (F16 or F17) with the snap ring groove facing up (toward the cylinder rod mounting eye).
7. Lubricate the ID of cylinder piston (F19) with clean hydraulic oil. Install the cylinder piston on cylinder rod (F16 or F17) with the O-ring relief (groove) (A) toward O-ring seal (F18). Install new self locking nut (F20) and tighten securely.

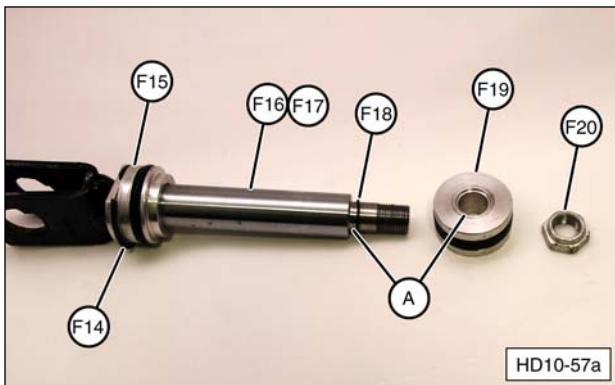

(F14) Snap Ring. (F15) Cylinder Cap.
 (F16 or F17) Cylinder Rod. (F18) O-ring Seal.
 (F19) Cylinder Piston (with seal). (F20) Self Locking Nut.

8. Lubricate cylinder tube (F21, F27) bore, piston (F19) seals, and cylinder cap (F15) seals. Install cylinder rod (F16, F17) assembly into the cylinder tube, being careful not to damage any seals.

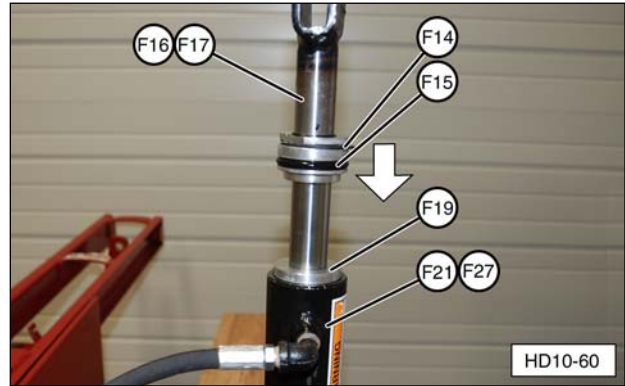

(F14) Snap Ring. (F15) Cylinder Cap.
 (F16 or F17) Cylinder Rod. (F19) Cylinder Piston
 (with seal). (F21, F27) Cylinder Tube.

9. Push cylinder rod into cylinder tube until snap ring (F14) in cylinder cap (F15) contacts the top of the tube.
10. Use heavy-duty snap ring pliers to completely compress snap ring (F14). Push cylinder cap (F15) into cylinder tube until the snap ring is completely seated in the snap ring groove.

NOTE: It may be necessary to use a soft (brass or wood) drift to tap the cylinder cap and snap ring into place. Use caution not to damage the aluminum cylinder cap.

! WARNING



Make sure the snap ring is completely seated in the cylinder tube groove. Failure to seat the snap ring in the groove can cause the cylinder cap to be explosively ejected from the tilt cylinder tube when hydraulic pressure is applied, resulting in serious injury or even death.

11. Install tilt cylinder(s) (F3, F4) with appropriate mounting pins (F7, F8, and/or D6) and secure with Lynch pins. Reconnect the hydraulic hoses.

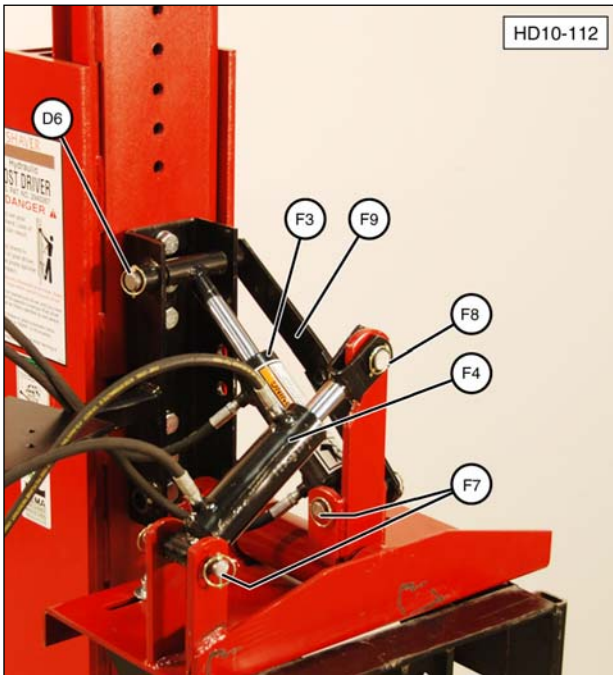

(D6) Short Channel Mounting Pin. (F3) Forward Tilt Cylinder. (F4) Side Tilt Cylinder. (F7) Mounting Pin. (F8) Short Mounting Pin.

Three-Point Hitch/Post Driver Assembly

1. With road lock pin (B8) installed in the lower hole of drive ram (A1), use a suitable overhead lifting device to raise (stand up) main carriage channel assembly (B1).

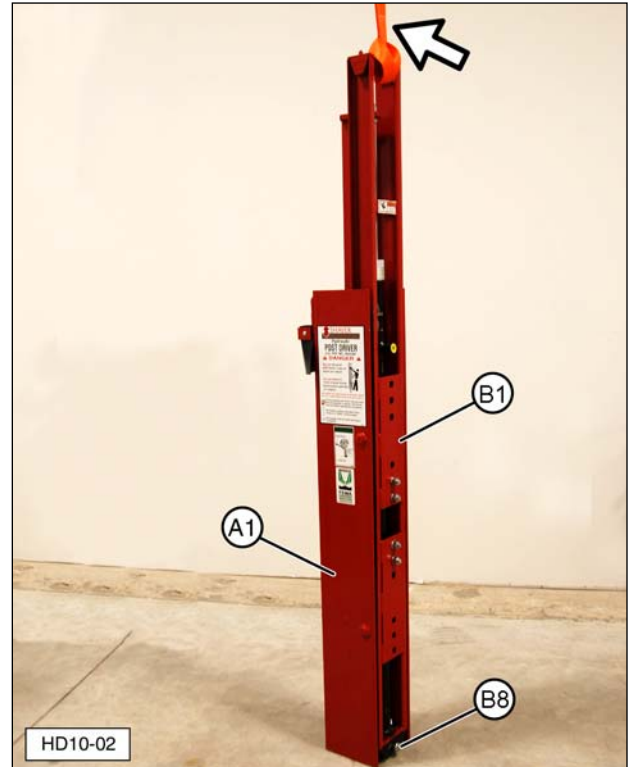

(A1) Drive Ram. (B1) Main Carriage Channel Assembly. (B8) Road Lock Pin.

! WARNING



The main carriage channel assembly is tall and heavy. To avoid tip over, resulting in serious injury or death, leave the overhead lifting device attached to the main carriage channel while assembling components.

2. To connect the three-point hitch and Post Driver assembly after service, refer to Step 5 in the Assembly Procedure, Base Plate section in this manual.

Service Parts

Driver Assembly

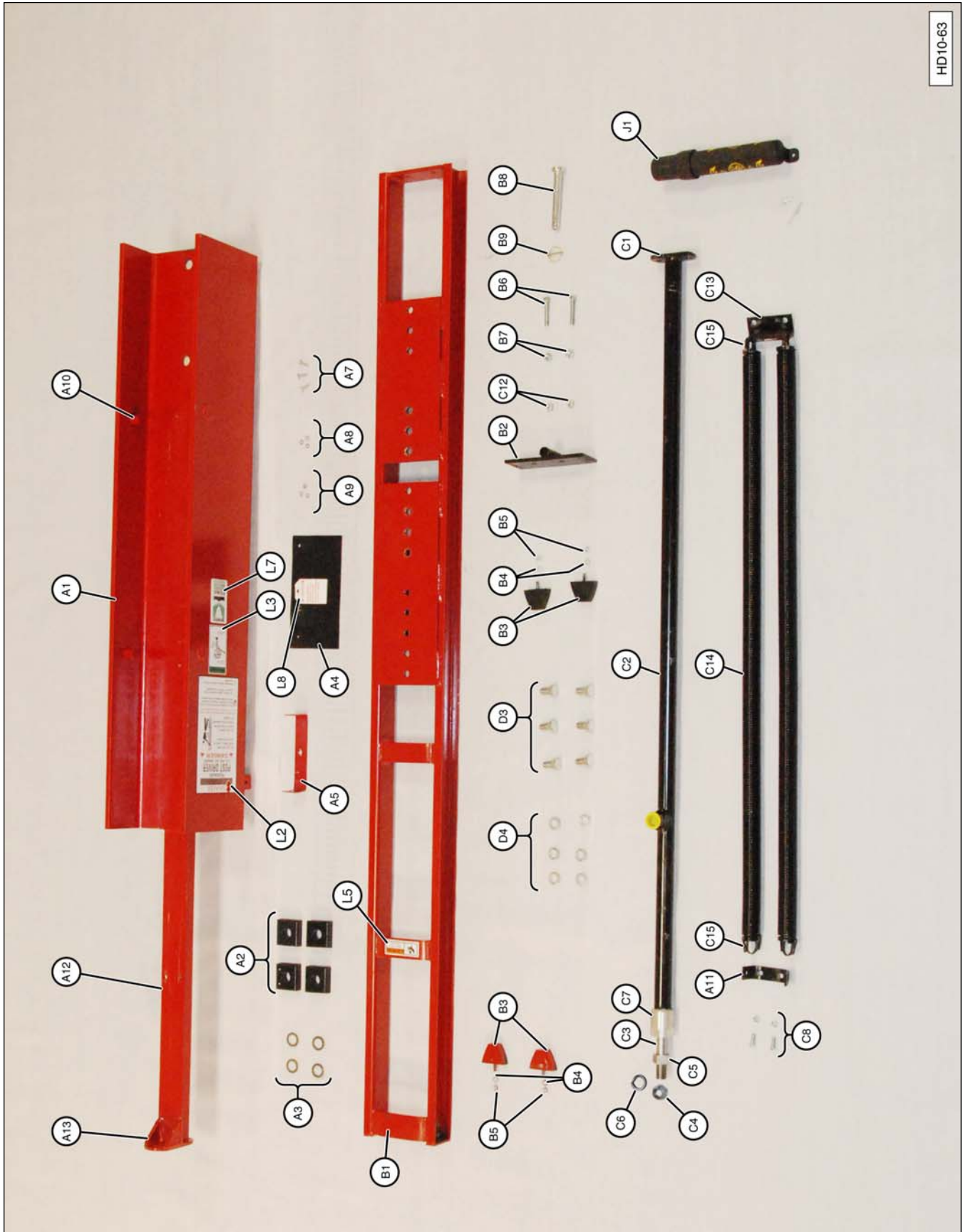

HD10-63

Driver Assembly

HD-10 Service Parts - Driver Assembly			
Item No.	Part No.	Description	Qty.
A1	SM-1011-DRC	Driving Ram Complete	1
	SM-1011-DRO	Driving Ram Only	1
A2	SM-00512	Guide Block	Pkg. of 4
A3	SM-0933-(18 ga)	Shim	4
	SM-9034-(14 ga)		
	SM-0935-(10 ga)		
A4	SM-1011-G	Rubber Debris Guard ¹	1
A5		Guard Mounting Strap	1
L8		Caution Tag	1
A7		Guard Mounting Bolt	3
A8		Guard Mounting Washer	3
A9		Guard Mounting Nut	3
A11	SM-1011-SBU	Upper Spring Bracket	1
B1	SM-10412	Main Carriage Channel	1
B2	SM-1041-RLB	Road Lock Bracket (no pin)	1
B3	SM-0041-B	Rubber Bumper ²	4
B4		Bumper Lock Washer, 5/16	4
B5		Bumper Nut, 5/16-18	4
B6	SM-093	Road Lock Bracket Bolt	2
B7	SM-932	Road Lock Bracket Nut	2
B8	SM-1041-RLP	Road Lock Pin	1
B9	SM-1041-RLC	Road Lock Pin Clip	1
C1	SM-1026	Cylinder Assembly	1
C2	SM-10261	Cylinder Tube	1
C3	SM-10266	Cylinder Piston/Rod	1
C4	SM-10267	Piston Self-Locking Nut	1
C5	SM-018	Cylinder Nut (with setscrew)	1
C6	SM-10268	Lock Washer	1
C7	SM-10262-D	Cylinder Cap (with seal)	1

HD-10 Service Parts - Driver Assembly (continued)			
Item No.	Part No.	Description	Qty.
C8	—	Bolts, Lock Washers, Nuts (upper spring bracket)	2
C12	SM-0931	Lower Bracket Lock Nut	2
C13	SM-1011-SBL	Lower Spring Bracket	1
C14	SM-1011-DRS	Spring (with spring clips installed)	2
C15	SM-1011-SC	Spring Clip Only	4
D3	S-012	Short Bracket Bolts 5/8-11 x 1-1/4	4
D4	S-013	Short Bracket Lock Washer, 5/8	4
D5	—	Short Bracket Nut, 5/8-11	4
J1	ODMAN	Document Storage Tube	1
L2	MS-161	Large "SHAVER" Decal	1
L3	MS-169	Control Valve Decal	1
L5	MS-181	Pinch Area Warning Decal	1
L7	MS-280	FEMA Member Decal	1
L9	MS-180	Cylinder Shaft Loose Decal (not visible)	1

¹ SM-1011-G Includes Items A4, A5, L8, A7, A8, and A9.

² SM-1041-B Includes Items B3, B4, and B5.

Drive Ram Weldment Parts

HD-10 Service Parts - Drive Ram Weldment			
Item No.	Part No.	Description	Qty.
A10	SM-1011-BS	Guide Pins ¹	4
A12	SM-1011-LYB	Lift Yoke Bar ¹	1
A13	SM-1011-LYTS	Lift Yoke Top ¹	1

¹ Replacement of these parts requires removal of old parts with a cutting torch and/or grinding wheel. New (replacement) parts must be welded to drive ram. This type of repair voids any warranties.

Manual Base Plate Assembly

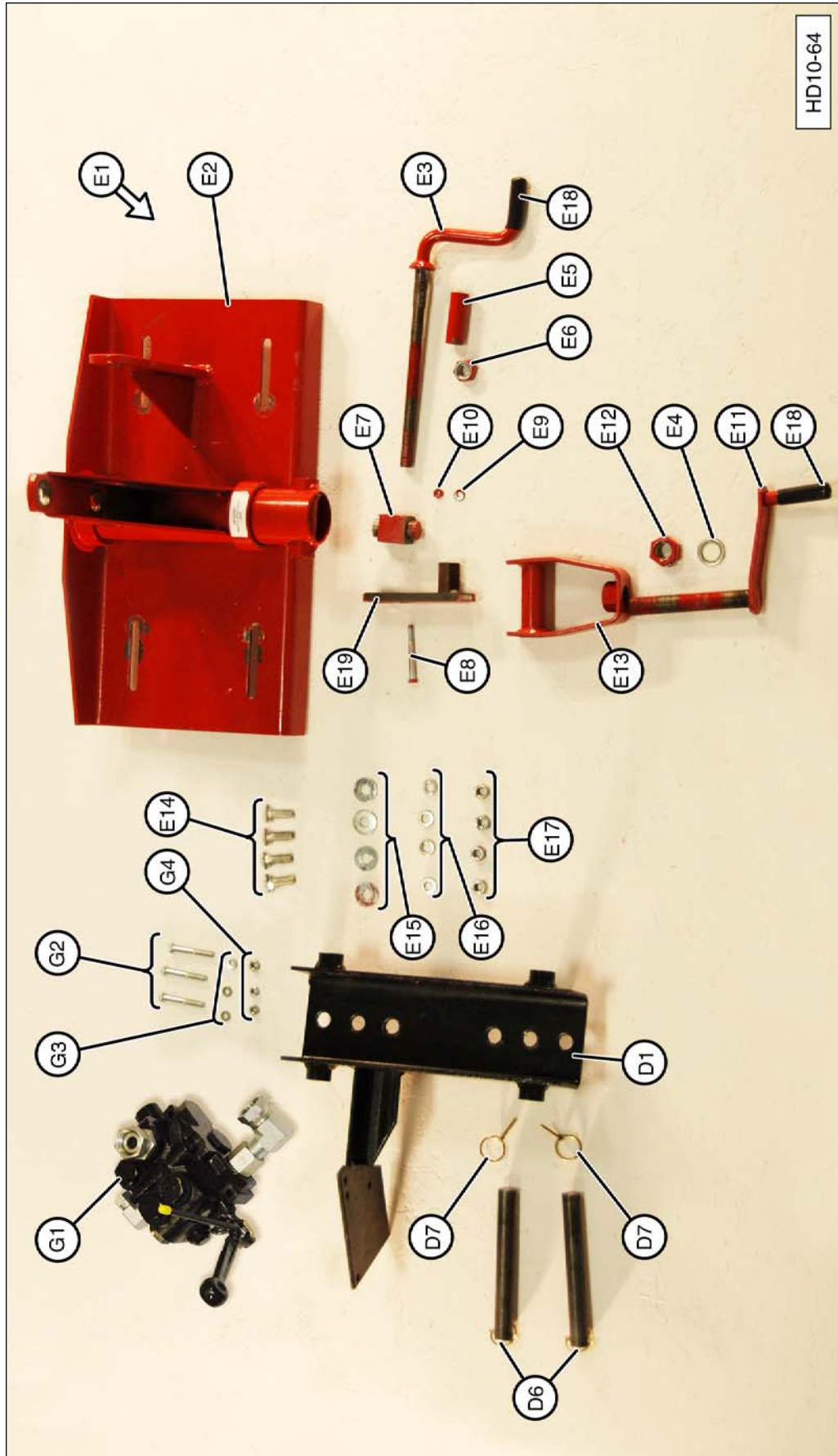

Manual Base Plate Assembly

HD-10 Service Parts - Manual Base Plate Assembly			
Item No.	Part No.	Description	Qty.
D1	SM-101	Short Channel (manual)	1
D6	SM-014	Channel Mounting Pin	2
D7	SM-2025-LP	Lynch Pin	4
E1	SM-1015-BPC	Complete Base Plate Assembly ¹	1
E2	SM-1015	Manual Base Plate	1
E3	SM-016	Side Tilt Crank	1
E4	S-20	Flat Washer	1
E5	SM-017	Side Tilt Crank Sleeve	1
E6	SM-018	Side Tilt Crank Nut (with setscrew)	1
E7	SM-2025-SB	Side Tilt Crank Screw Block	1
E8	—	Screw Block Mounting Bolt, 5/16-18 x 3"	1
E9	—	Screw Block Lock Washer, 5/16	1
E10	—	Screw Block Mounting Nut, 5/16-18	1
E11	SM-019	Forward Tilt Crank	1
E12	SM-021	Forward Tilt Nut (with setscrew) ²	1
E13	SM-022	End Tilt Tee	1

HD-10 Service Parts - Manual Base Plate Assembly (continued)			
Item No.	Part No.	Description	Qty.
E14	—	Base Plate Mounting Bolt, 5/8-11 x 1-1/2 ³	4
E15	—	Base Plate Flat Washer, 5/8 ³	4
E16	—	Base Plate Lock Washer, 5/8 ³	4
E17	—	Base Plate Mounting Nut, 5/8-13 ³	4
E18	SM-015-CC	Crank Handle Cover	2
E19	SM-2025-SBS	Crank Screw Block Support	1
G1	P-20	Hydraulic Control Valve	1
	P-2012	Seal Kit for P-20 Valve, not shown	1
G2	—	Valve Mounting Bolt, 5/16-18 x 3	3
G3	—	Valve Mounting Washer, 5/16	3
G4	—	Valve Mounting Nut, 5/16-18	3

¹ Includes Short Channel, Pins, Cranks, Stops, etc.

² Or S-095 Nut (with setscrew).

³ S-1092 Kit Includes Items E14, E15, E16, and E17.

NOTE: All hardware is Grade 5.

Hydraulic Base Plate Assembly

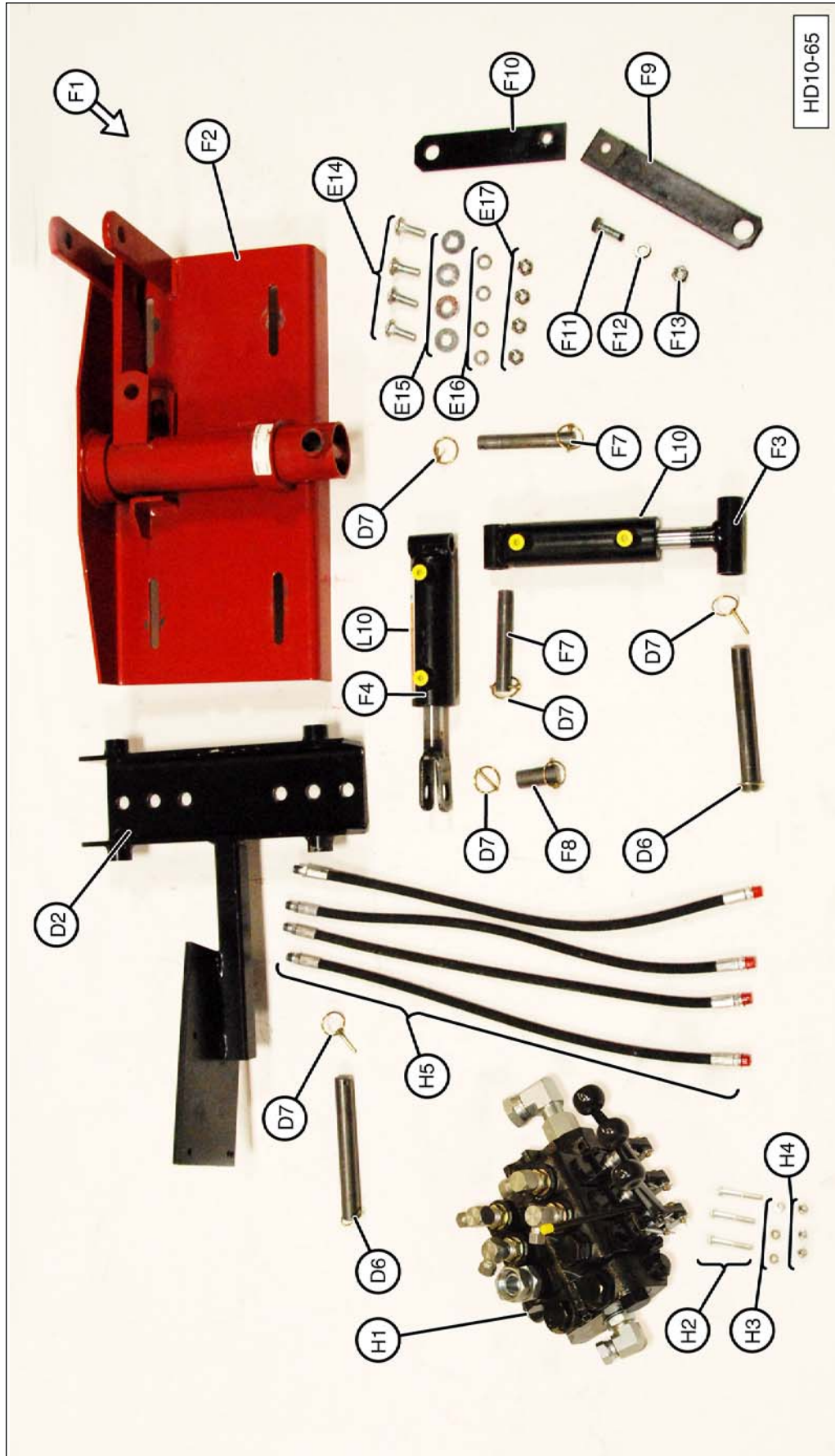

Hydraulic Base Plate Assembly

HD-10-H Service Parts - Hydraulic Base Plate Assembly			
Item No.	Part No.	Description	Qty.
D2	HBP-909	Short Channel (hydraulic) ¹	1
D6	SM-014	Channel Mounting Pin	2
D7	SM-2025-LP	Lynch Pin	10
E14	—	Base Plate Mounting Bolt, 5/8-11 x 1-1/2 ³	4
E15	—	Base Plate Flat Washer, 5/8 ³	4
E16	—	Base Plate Lock Washer, 5/8 ³	4
E17	—	Base Plate Mounting Nut, 5/8-11 ³	4
F1	HD-10-HCK	Hydraulic Conversion Kit ¹	1
F2	HBP-91011	Hydraulic Base Plate	1
F3/F4	HBP-908120	Cylinder Kit Complete ²	1
F3	HBP-90812	Forward Tilt Cylinder	1
F4	HBP-90813	Side Tilt Cylinder	1
F5	HBP-908131	Cylinder Seal Kit, not shown	1
F7	HBP-908133	Cylinder Mounting Pin	2
F8	HBP-908134	Side Tilt Mounting Pin	1

HD-10-H Service Parts - Hydraulic Base Plate Assembly (continued)			
Item No.	Part No.	Description	Qty.
F9	—	Cylinder Stop Plate, 8.5 ^{2,4}	1
F10	—	Cylinder Stop Plate, 10.5 ^{2,4}	1
F11	—	Cylinder Stop Bolt, 1/2-13 x 1-3/4 ^{2,4}	1
F12	—	Cylinder Stop Lock Washer, 1/2 ^{2,4}	1
F13	—	Cylinder Stop Nut, 1/2-13 ^{2,4}	1
H1	P-23	Hydraulic Control Valve	1
—	P-2312	Seal Kit for P-23 Valve, not shown	3
H2	—	Valve Mounting Bolt, 5/16-18 x 3	3
H3	—	Valve Mounting Washer, 5/16	3
H4	—	Valve Mounting Nut, 5/16-18	3
H5	SM-02111-P	Tilt Cylinder Hose	4
L10	MS-171	High-Pressure Warning Decal	2

- ¹ HD-10-HCK Kit Includes Items D2, F2, and F3/F4.
- ² HBP-908120 Kit Includes Items F3, F4, and F9 Through F13.
- ³ S-1092 Kit Includes Items E14, E15, E16, and E17.
- ⁴ HBP-908-CS Kit Contains Items F9, F10, F11, F12, and F13.

NOTE: All hardware is Grade 5.

Three-Point Hitch Assembly

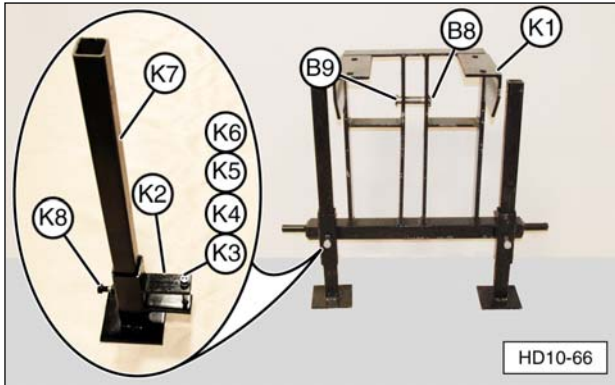

HD-10 Service Parts - Three-Point Hitch Assembly

Item No.	Part No.	Description	Qty.
B8	MB-1201A-12	Upper Link Hitch Pin	1
B9	SM-2025-LP	Lynch Pin	1
K1	MB-1201-A	Three-Point Hitch Weldment	1
K2	OS-4-22-SFB	Leg Bracket Weldment ¹	2
K3	—	Leg Bracket Bolt, 1/2-13 x 4 ¹	2
K4	—	Leg Bracket Flat Washer, 1/2 ¹	2
K5	—	Leg Bracket Lock Washer, 1/2 ¹	2
K6	—	Leg Bracket Nut, 1/2-13 ¹	2
K7	OS-4-22-SSA	Stabilizer Leg Only ¹	2
K8	—	Stabilizer Leg Lock Bolt, 5/8-11 x 1-1/2 ¹	2

¹ OS-4-22 Stabilizer Leg Kit Includes Items K2 Through K8.

Hydraulic Hoses

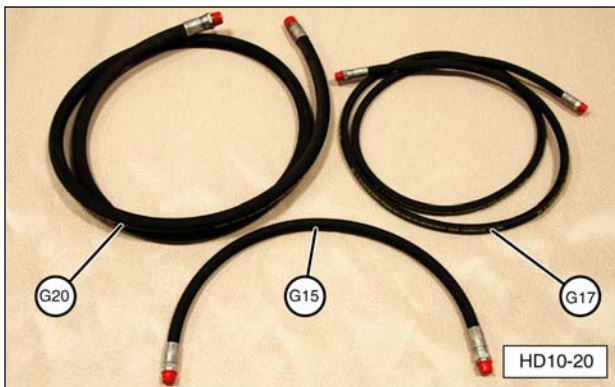

HD-10 Service Parts - Hydraulic Hoses

Item No.	Part No.	Description	Qty.
G15	SM-1023-P	Valve to Drive Ram Hose ¹	1
G17	SM-0234-P	Power Supply to Valve Hose ²	1
G20	SM-1025-R	Valve to Tank Return Hose ³	1

¹ 1" ID x 35" long. ² 1/2" ID x 120" long. ³ 1" ID x 120" long.

Safety Arm Assembly

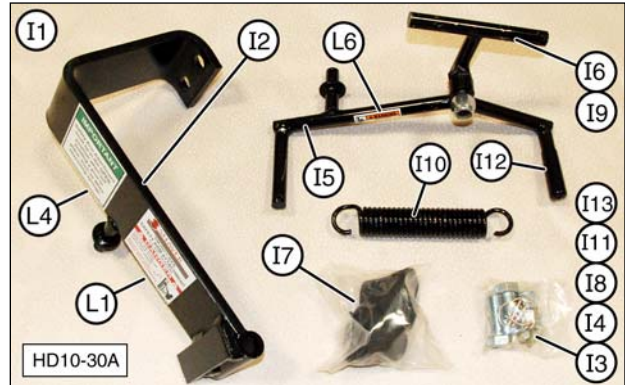

HD-10 Service Parts - Safety Arm Assembly

Item No.	Part No.	Description	Qty.
I1	SM-0011-SAA	Safety Arm Attachment ¹	1
I2	SM-0011-SAAC	Safety Arm Frame	1
I3	—	Frame Mounting Bolt, 3/4-13 x 2	2
I4	—	Self-Locking Nut, 3/4-13	2
I5	SM-0011-SAAD	Swing Arm Handle	1
I6	SM-0011-SAA15	Roller Holder Swivel ²	1
I7	SM-0011-SAA16	Roller ²	2
I8	—	Roller Retainer Roll Pin ²	2
I9	—	Roller Bracket Nut, 3/4-13	1
I10	SM-0011-SAA2	Latch Spring	1
I11	SM-0011-SAA7	Flat Washer, 3/4	2
I12	SM-015-CC	Swing Arm Handle Cover	1
I13	SM-2025-LP	Lynch Pin, 3/16 x 1-7/8	3
L1	MS-165	Small "SHAVER" Decal	1
L4	MS-166	Safety Arm Decal	1
L6	MS-181	Pinch Area Warning Decal	1

¹ Complete Safety Arm Kit (Items I2 through L6).

² SM-0011-SAA13C Includes Items I6, I7, and I8.

Replacement Decals



HD-10 Service Parts - Replacement Decals			
Item No.	Part No.	Description	Qty.
L1	MS-165	Small SHAVER Decal	1
L2	MS-161	Large SHAVER Decal	1
L3	MS-169	Control Valve Decal	1
L4	MS-166	Safety Arm Decal	1
L5	MS-163	Pinch Area Warning Decal	1
L6	MS-181	Pinch Point Warning Decal	1
L7	MS-280	FEMA Member Decal	1
L8	SM-0011-ST	Caution Tag	1
L9	MS-180	Cylinder Shaft Decal	1
L10	MS-171	High-Pressure Warning Decal	1

Document Storage Tube

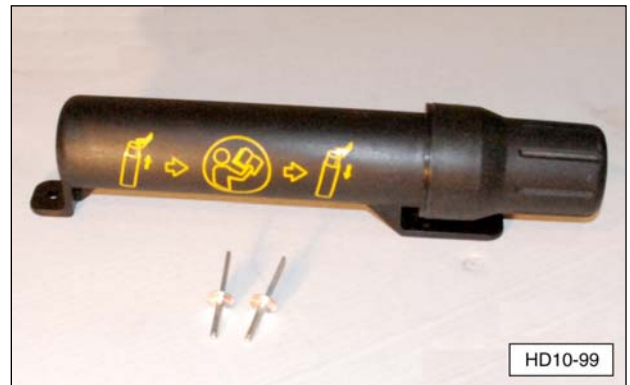

HD-10 Service Parts - Document Tube			
Item No.	Part No.	Description	Qty.
J1	ODMAN	Document Tube (with rivets)	1

Hydraulic Control Valves

Single Control Lever Valve

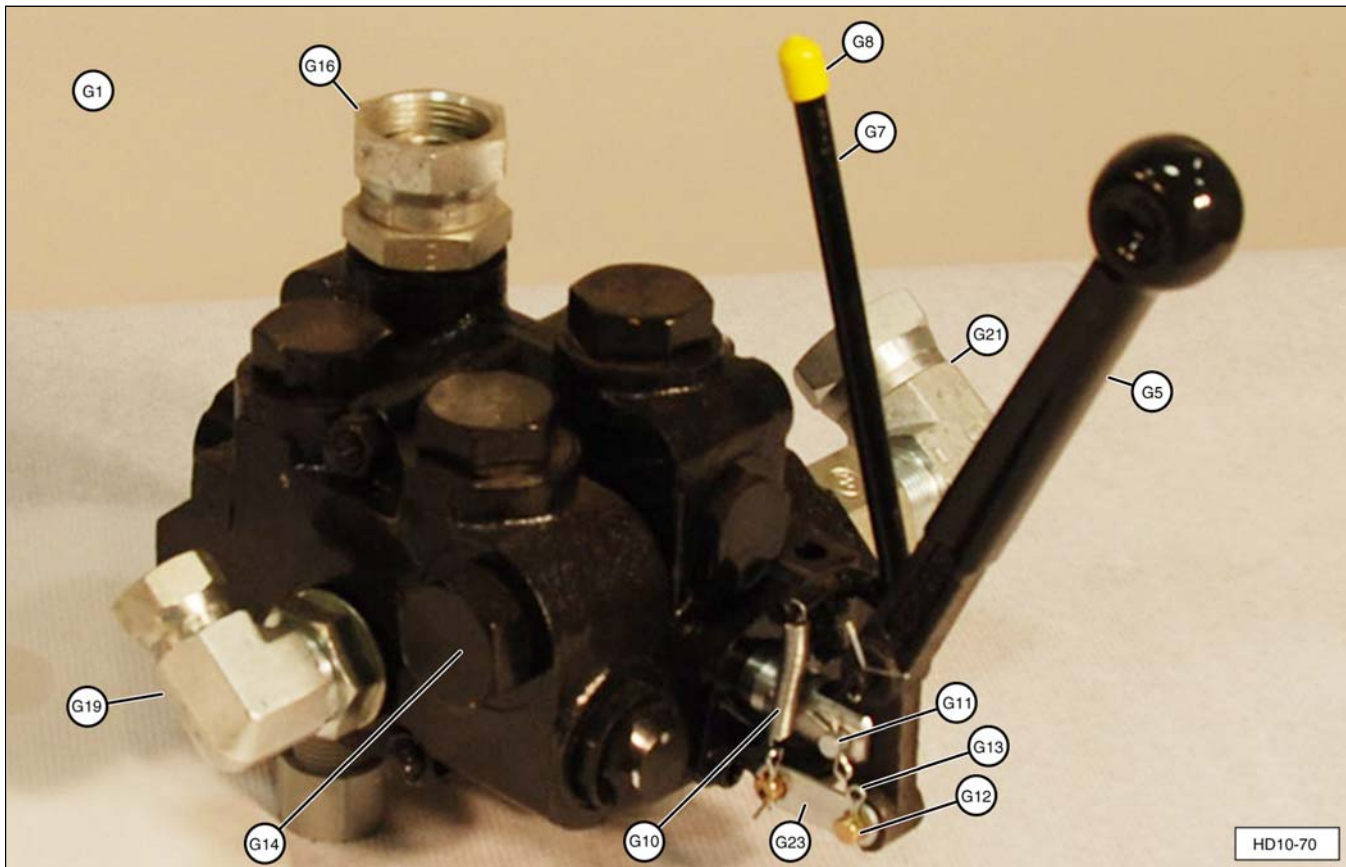

HD10-70

HD-10 Service Parts - Single Control Lever Valve

Item No.	Part No.	Description	Qty.
G1	P-20	Control Valve (complete)	1
	P-2012	Seal Kit for P-20 Valve	1
G5	P-202	Control Valve Lever Only ^{1,2}	1
G7	GS-001	Control Valve Safety Lever	1
G8	GS-001-2	Safety Lever Plastic Cap	1
G10	GS-001-3	Safety Lever Return Spring	1
G11	P-206	Lever Clevis Pin	1
G12	P-209	U-Link	1
G13	P-205	Cotter Pin	4
G14	P-207A	Open Center Plug Kit ³	1
G16	P-910182	O-Ring Swivel Fitting 3/4" Male x 1" Female	1
G19	P-910183	O-Ring Swivel 90° Fitting 1-1/16-12 Male to 1/2" Female	1

HD-10 Service Parts - Single Control Lever Valve (continued)

Item No.	Part No.	Description	Qty.
G21	P-910184	Pipe Thread Adapter Fitting 1-1/16"-12 O-Ring Male to 3/4" Pipe Thread Female	1
		90° Pipe Thread Swivel Fitting 3/4" Male to 1" NPT Female	1
G23	P-208	Flat Link	1

¹ P-201 Kit Includes Items G5, G11, G12, G13, and G23.

² P-202A Kit Includes Items G5, G7, G8, and G10.

³ Standard. Optional P207 Plug Kit required for "Closed Center" valve operation.

NOTE: For more information on hydraulic valve parts, contact the following suppliers:

- Gresen valve (painted red):
Parker Hannifin Corporation
Phone (440)-366-5200
- Prince valve (painted black):
Prince Manufacturing Corporation
Phone (605) 235-1220

Triple Control Lever Valve

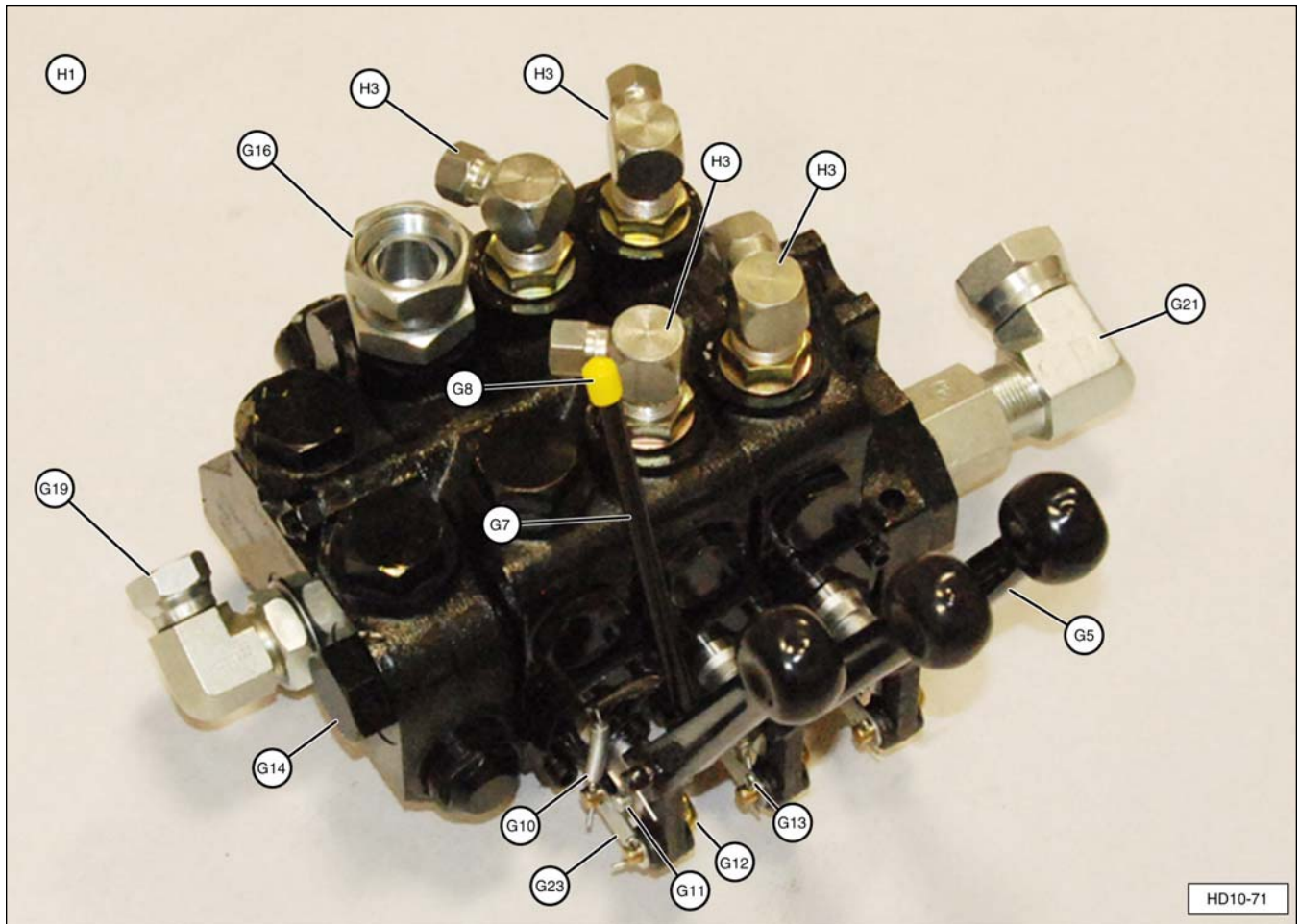

HD-10-H Service Parts - Triple Control Lever Valve

Item No.	Part No.	Description	Qty.
H1	P-23	Control Valve (complete)	1
—	P-2012	Seal Kit for P-23 Valve ⁴	3
H3	P-910181	90° O-Ring Swivel Fitting (with restrictor) 7/8-14 Male to 1/4 Female	4
G5	P-202	Control Valve Lever Only ^{1, 2}	3
G7	GS-001	Control Valve Safety Lever	1
G8	GS-001-2	Safety Lever Plastic Cap	1
G10	GS-001-3	Safety Lever Return Spring	1
G11	P-206	Lever Clevis Pin	3
G12	P-209	U-Link	3
G13	P-205	Cotter Pin	8
G14	P-207A	Open Center Plug Kit ³	1
G16	P-910182	O-Ring Swivel Fitting 3/4" Male x 1" Female	1

**HD-10-H Service Parts - Triple Control Lever Valve
(continued)**

Item No.	Part No.	Description	Qty.
G19	P-910183	O-Ring Swivel 90° Fitting 1-1/16-12 Male to 1/2" Female	1
G21	P-910184	Pipe Thread Adapter Fitting 1-1/16"-12 O-Ring Male to 3/4" Pipe Thread Female	1
		90° Pipe Thread Swivel Fitting 3/4" Male to 1" NPT Female	1
G23	P-208	Flat Link	1

¹ P-201 Kit Includes Items G5, G11, G12, G13, and G23.

² P-202A Kit Includes Items G5, G7, G8, and G10.

³ Standard. Optional P207 Plug Kit required for "Closed Center" valve operation.

⁴ One P-2012 Seal Kit required for each section of P23 Valve.

Drive Cylinder Assembly

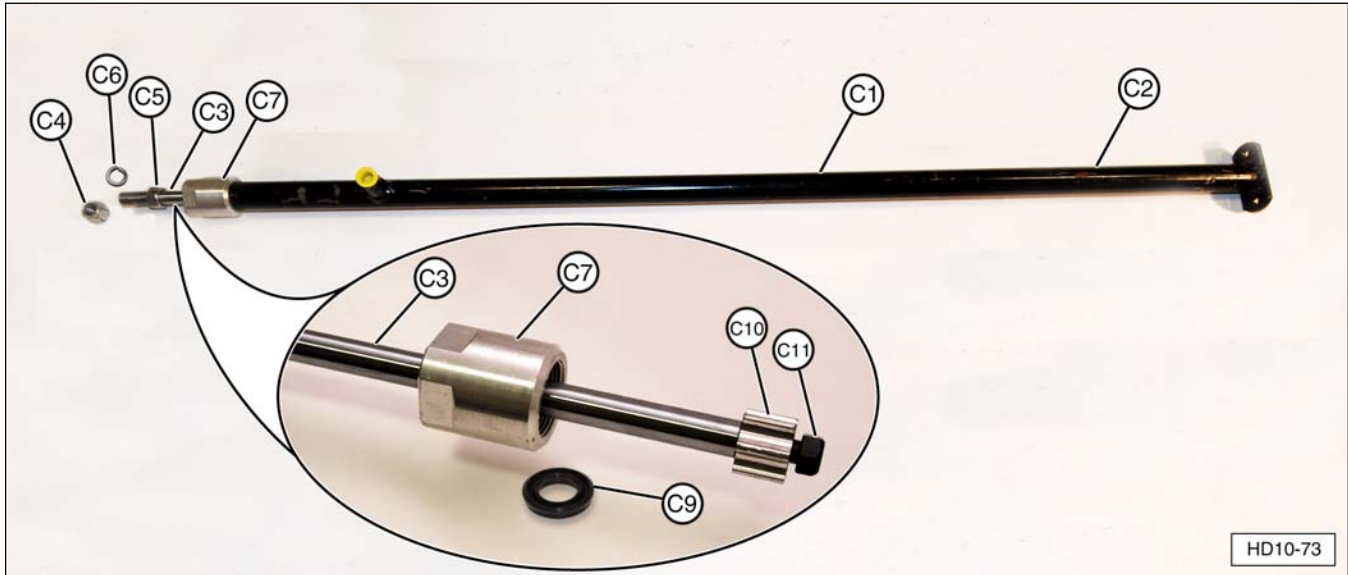

Expanded View Of Safety Lever Assembly

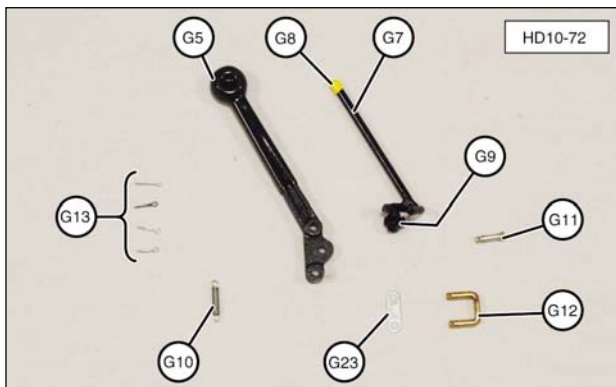

HD-10 Service Parts - Drive Ram Cylinder Assembly

Item No.	Part No.	Description	Qty.
C1	SM-1026	Drive Ram Cylinder (complete)	1
C2	SM-10261	Drive Ram Cylinder Tube	1
C3	SM-10266	Drive Ram Cylinder Piston Rod	1
C4	SM-10267	Self-Locking Nut	1
C5	SM-018	Nut With Setscrew	1
C6	SM-10268	Spring Lock Washer	1
C7	SM-10262	Cylinder Cap With Seal	1
C9	SM-10265-D	Cylinder Cap Seal Only	1
C10	SM-02610	Piston Rod Guide	1
C11	SM-0269	Self-Locking Piston Guide Nut	1

HD-10 Service Parts - Safety Lever Assembly Detail

Item No.	Part No.	Description	Qty.
G5	P-202	Control Valve Lever Only	1
G7	GS-001	Control Valve Safety Lever	1
G8	GS-001-2	Safety Lever Plastic Cap	1
G9	—	Safety Lever Stop Setscrew	1
G10	GS-001-3	Safety Lever Return Spring	1
G11	P-206	Lever Clevis Pin	3
G12	P-209	U-Link	3
G13	P-205	Cotter Pin	4
G23	P-208	Flat Link	1

Tilt Cylinder Assembly

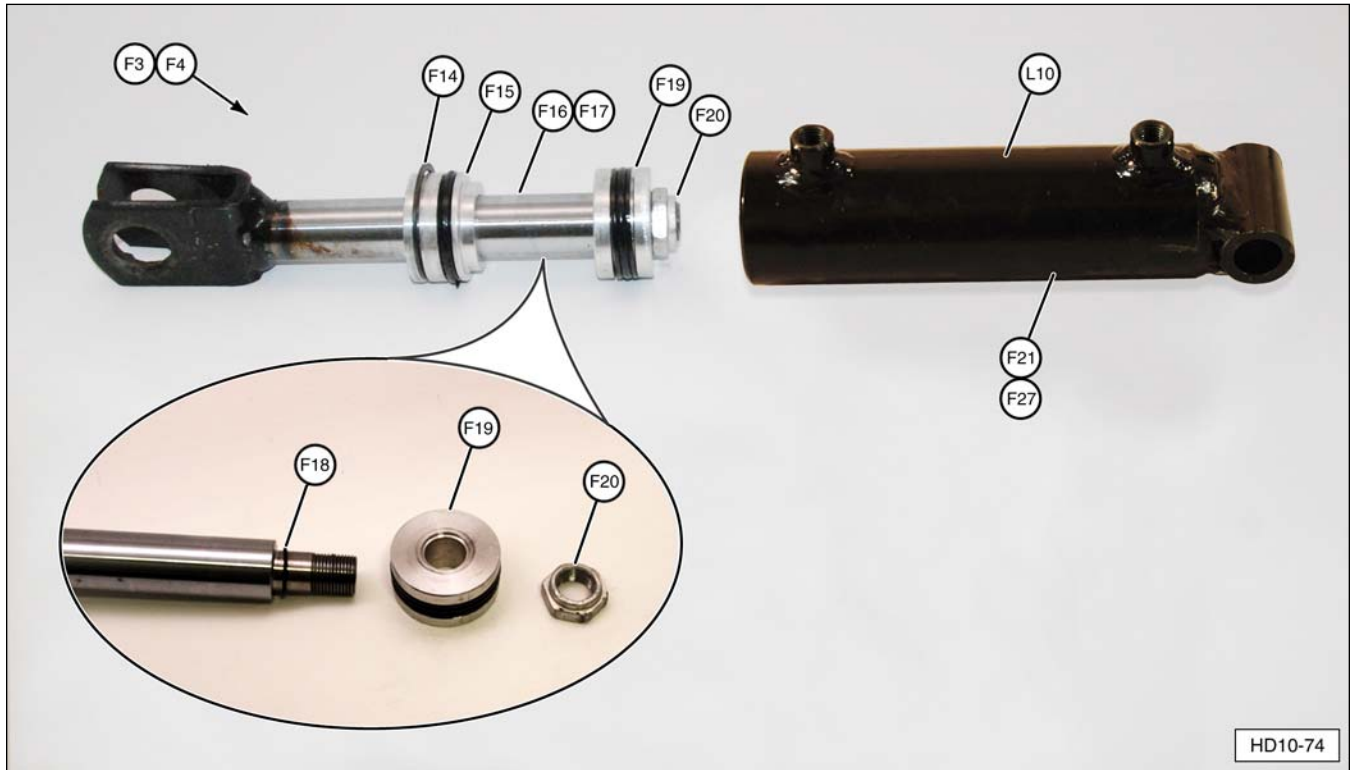

HD10-74

HD-10-H Service Parts - Fwd & Side Tilt Cylinder Assembly

Item No.	Part No.	Description	Qty.
F3	HBP-90812	Forward Tilt Cylinder ¹	1
F4	HBP-90813	Side Tilt Cylinder ¹	1
F5	HBP-908131	Tilt Cylinder Seal Kit, ² not shown	1
F14	HBP-908139	Snap Ring	1
F15	HBP-908136	Tilt Cylinder Cap/Gland	1
F16	HBP-90813-A	Side Tilt Cylinder Rod	1
F17	HBP-908121	Forward Tilt Cylinder Rod	1
F18	—	O-Ring Seal	1
F19	HBP-908137	Cylinder Piston	1
F20	HBP-908138	Piston Rod Self-Locking Nut	1
F21	HBP-90809	Fwd. Tilt Cylinder Tube Only	1
F22	—	External O-Ring Seal	1
F23	—	Internal O-Ring Seal	1
F24	—	Internal Lip Seal	1
F25	—	Scraper Seal	2
F26	—	O-Ring Seal	1
F27	HBP-90810	Side Tilt Cylinder Tube Only	1
L10	MS-171	High-Pressure Warning Decal	1

¹ Complete Tilt Cylinder.

² Includes Items F18, F22, F23, F24, F25, and F26.
(one seal kit required per cylinder.)

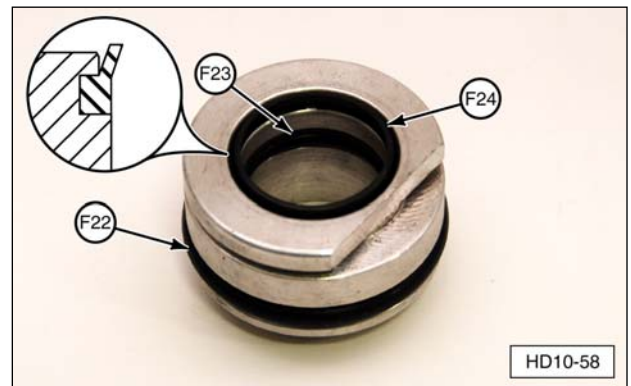

HD10-58

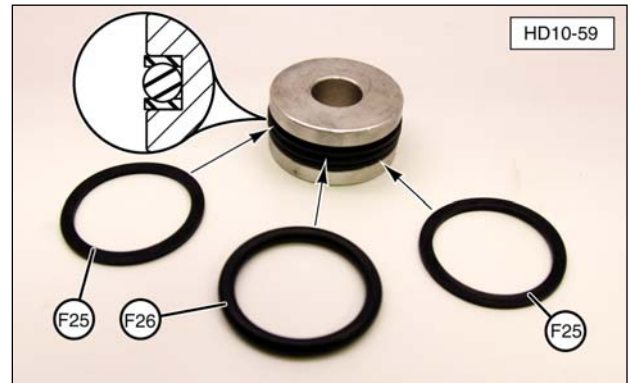

HD10-59



Shaver Manufacturing Co., LLC.
103 South Washington Avenue
P.O. Box 358
Graettinger, IA 51342
Phone: (712) 859-3293
Fax: (712) 859-3294
sales@shavermfg.com

Limited Warranty

Shaver Manufacturing Company, LLC warrants each new Shaver product to be free from defects in material and workmanship. This warranty is applicable only for the normal service life expectancy of the product or components, not to exceed 12 consecutive months from the date of delivery of the new Shaver product to the original purchaser.

Genuine Shaver replacement parts and components will be warranted for 90 days from the date of purchase, or the remainder of the original equipment warranty period, whichever is longer.

Rubber Bumpers, Carbide Teeth, Auger Teeth and Auger Points are usable parts and not covered by warranty. Part No. SD-101-GB and SD-0301-GB Gearbox are warranted for 3 years from the date of purchase. Part No. SD-0607-GB and SD-0907-GB Gearbox are warranted for 5 years from the date of purchase. Part No. SL-2030-1 5" Cylinder for the Logsplitter is warranted for 4 years from the date of purchase. Driving Ram Springs are warranted for 60 days from the date of purchase for residential customers and 30 days from the date of purchase with a limit of 2 claims per serial numbered unit for commercial users. Tires are warranted for 90 days from the date of purchase.

Under no circumstances will it cover any merchandise or components thereof, which, in the opinion of the company, have been subjected to misuse, unauthorized modification, alteration, an accident, or if a repair has been made with parts other than those obtainable through Shaver.

Our obligation under this warranty shall be limited to repairing or replacing any part that, in our judgment, shall show evidence of such defect, provided further that such part shall be returned within thirty (30) days from the date of failure to Shaver, routed through the dealer and distributor from whom the purchase was made, transportation charges prepaid. All returned items must have an RGA number. Contact Shaver at 712-859-3293 to get authorization to return, file your warranty claim and, if needed, an RGA will be provided.

This warranty shall not be interpreted to render Shaver liable for injury or damages of any kind or nature to person or property. This warranty does not extend to the loss of crops, loss because of delay in harvesting, or any expense or loss incurred for labor, substitute machinery, rental, or for any other reason.

Except as set forth above, **Shaver shall have no obligation or liability of any kind on account of any of its equipment and shall not be liable for special or consequential damages. Shaver makes no other warranty, expressed or implied, and specifically, Shaver disclaims any implied warranty of merchantability or fitness for a particular purpose. Some states or provinces do not permit limitations or exclusions of implied warranties or incidental or consequential damages, so the limitations or exclusion in this warranty may not apply.**

This warranty is subject to any existing conditions of supply which may directly affect our ability to obtain materials or manufacture replacement parts.

Shaver reserves the right to make improvements in design or changes in specifications at any time, without incurring any obligation to owners of units previously sold.

No one is authorized to alter, modify, or enlarge this warranty, nor the exclusion, limitations, and reservations.

Effective January 1, 2009

Warranty Card

The Post Driver is shipped from the factory with a warranty card. If the card is lost or misplaced, please copy this page, fill in the information, and send it to Shaver Manufacturing Company.

Warranty Card

Please complete the warranty card and return to:

Shaver Manufacturing Company
103 South Washington Avenue
P.O. Box 358
Graettinger, Iowa 51342

Name _____

Address _____

City _____ State _____ Zip Code _____

Purchase / Delivery Date _____

Shaver Model Number _____

Serial Number _____

