

# SHAYER

## HYDRAULIC POST HOLE DIGGER

### OPERATOR'S MANUAL

### MODEL 510/1020

Shaver Manufacturing Co.  
Graettinger, Iowa 51342 • (712) 859-3293



**TO THE OWNER:**

Read this manual before operating your equipment. The information presented will prepare you to do a better and safer job. Keep this manual handy for ready reference. Require all operators to read this manual carefully and become acquainted with all the adjustment and operating procedures before attempting to operate. Replacement manuals can be obtained from your dealer or, in the United States and Canada, by calling 1-712-859-3293.

The equipment you have purchased has been carefully engineered and manufactured to provide dependable and satisfactory use. Like all mechanical products, it will require cleaning and upkeep. Lubricate the unit as specified. Observe all safety information in this manual and safety decals on the equipment.

For service, your authorized dealer has trained mechanics, genuine service parts, and the necessary tools and equipment to handle all your needs.

Use only genuine service parts. Substitute parts will void the warranty and may not meet standards required for safe and satisfactory operation. Record the model number and serial number of your equipment in the spaces provided:

**Model:** \_\_\_\_\_

**Date of Purchase:** \_\_\_\_\_

**Serial Number:** \_\_\_\_\_

Provide this information to your dealer to obtain correct repair parts.

Throughout this manual, the term **IMPORTANT** is used to indicate that failure to observe can cause damage to equipment. The terms **CAUTION**, **WARNING** and **DANGER** are used in conjunction with the Safety-Alert Symbol (a triangle with an exclamation mark), to indicate the degree of hazard for items of personal safety.



This Safety-Alert Symbol indicates a hazard and means **ATTENTION! BECOME ALERT! YOUR SAFETY IS INVOLVED!**



Indicates an imminently hazardous situation that, if not avoided, will result in death or serious injury.



Indicates a potentially hazardous situation that, if not avoided, could result in death or serious injury, and includes hazards that are exposed when guards are removed.



Indicates a potentially hazardous situation that, if not avoided, may result in minor or moderate injury.



Indicates that failure to observe can cause damage to equipment.



Indicates helpful information.

# SAFETY DECALS

|  |   |  |
|--|---|--|
| <b>⚠ DANGER</b>  |   |  |
| <b>GUARD MISSING</b><br><small>When this is visible</small><br><b>DO NOT OPERATE</b>   |  | <b>KEEP CLEAR!</b><br><small>Keep Others Away!</small><br><b>ENTANGLEMENT HAZARD</b><br><small>can cause Serious Injury or Death</small> |
| <p><i>Si no entiende ingles, se prefiere que busque a alguien que interprete las instrucciones para usted.</i></p> <ul style="list-style-type: none"> <li>• Never manually position the auger or manually force the auger into the ground.</li> <li>• This machine is designed to be operated <b>ONLY</b> from the tractor seat.</li> <li>• Keep everyone clear of all moving parts of the digger while in operation.</li> </ul> |   |  |

PHDC-5

|  |   |   |
|--|---|---|
| <b>⚠ DANGER</b>  |   |   |
| <p><b>TO PREVENT SERIOUS INJURY OR DEATH:</b></p> <ul style="list-style-type: none"> <li>• Contact dealer, make sure your machine has all current safety guards and shields in place.</li> <li>• Do not operate without all guards and shields in place.</li> <li>• Do not operate when auger is higher than 12 inches above ground level. Doing so may cause driveline to bind, resulting in equipment damage or operator injury.</li> <li>• Stop auger rotation before maneuvering, relocating or transporting.</li> </ul> |  | <p><b>TO PREVENT SERIOUS INJURY OR DEATH:</b></p> <p><i>Si no entiende ingles, se prefiere que busque a alguien que interprete las instrucciones para usted.</i></p> <p>Read and understand owner's manual before operating.</p> <p>Operate only from the tractor or skidloader seat.</p> <p>Stay away from rotating parts. Keep others away.</p> <p>Do not dig around underground utility lines without checking with authorities.</p> |

MS-511

|   |          |
|---|----------|
| <b>!</b>  | <b>!</b> |
| <p><b>FOR CONTINUOUS FLOW:</b><br/><b>DO NOT USE on Power Unit with Hydraulics</b><br/><b>exceeding 20 GPM or 3000 PSI.</b></p> |          |
| MS-512  |          |

MS-512 (510 only)

|   |          |
|---|----------|
| <b>!</b>  | <b>!</b> |
| <p><b>FOR CONTINUOUS FLOW:</b><br/><b>DO NOT USE on Power Unit with Hydraulics</b><br/><b>exceeding 25 GPM or 3000 PSI.</b></p> |          |
| MS-513  |          |

MS-513 (1020 only)

|  |                  |
|--|------------------|
| <b>IMPORTANT</b>   |                  |
| <p><b>Gearbox does NOT</b><br/><b>contain oil. Fill with</b><br/><b>SAE 90 before operating.</b></p> |                  |
| 301 - 1 Qt.  | 601 - 2 Qt.      |
| 901 - 3 Qt.  | 510/1020 - 2 Qt. |
| MS-211   |                  |

MS-211



# **SAFETY RULES**

## **ATTENTION! BECOME ALERT! YOUR SAFETY IS INVOLVED!**



- Ensure all safety decals are installed. Replace if damaged.
- Ensure shields and guards are properly installed and in good condition. Replace if damaged.
- Before drilling, check to make sure that you will not drill into wires or other objects.

### **OPERATIONAL SAFETY**

- Improper operation can cause the machine to tip or roll over and cause injury or death.
  - Keep skid steer lift arms and attachment as low as possible.
  - Do not travel until hydraulic digger is resting in transport bracket.
  - Turn on level ground.
  - Go up and down slopes, not across them.
  - Keep the heavy end of the machine uphill.
  - Do not overload the machine.
- Never use attachment to carry loads that exceed power unit rated operating capacity or other specifications. Check your power unit manual or see your dealer for rated operating capacity. Exceeding this capacity can cause machine to tip, roll over, or present other hazards that can cause injury or death.
- Do not allow other people in the area when operating, attaching, removing, assembling or servicing equipment.
- Consult local utilities before digging. Know location and depth of, and avoid contacting, all underground cables, pipelines, and other hazards in working area.
- Contact with high voltage, overhead power lines, underground cables, gas lines, and etc. can cause serious injury or death from electrocution, explosion, or fire.
- Keep bystanders away from equipment.
- Do not operate equipment while under the influence of alcohol or drugs.
- Operate only in daylight or good artificial light.
- Keep hands, feet, hair and clothing away from equipment while engine is running. Stay clear of all moving parts.
- Always comply with all state and local lighting and marking requirements.
- Do not allow riders. Do not lift or carry anybody on the skid steer or attachments.
- Always sit in skid steer seat when operating controls or starting engine. Securely fasten seat belt/operator restraint, place transmission in park or neutral, engage brake and ensure all other controls are disengaged before starting skid steer engine.
- When digging holes, always sit in operator seat.
- Keep digger under control by running drive motor at slowest speed possible.
- Look down and to the rear and make sure area is clear before operating in reverse.
- Use extreme care when working close to fences, ditches, other obstructions, or on hillsides.
- Do not operate on steep slopes.
- Do not stop, start or change directions suddenly on slopes.
- Use extreme care and reduce ground speed on slopes and rough terrain.
- Watch for hidden hazards on the terrain during operation.
- Stop skid steer and implement immediately upon striking an obstruction. Dismount skid steer using proper procedure. Inspect and repair any damage before resuming operation.
- Before leaving operator's seat, follow power unit manual instructions. Lower lift arms and put attachment on the ground. Stop engine, remove key, engage brake, and remove seat belt/operator restraint.
- Lower digger to ground or block securely, turn skid steer engine off, remove key and disconnect hydraulic lines from skid steer before performing any service or maintenance.
- Never go underneath equipment lowered to the ground or raised. Never place any part of the body underneath equipment or between moveable parts even when the engine has been turned off. Hydraulic system leak down, hydraulic system failures, mechanical failures or movement of control levers can cause equipment to drop or rotate unexpectedly and cause severe injury or death.
  - Service work does not require going underneath.
  - Read operator's manual for service instructions or have done by a qualified dealer.

*(Safety Rules continued on next page)*



# SAFETY RULES

## ATTENTION! BECOME ALERT! YOUR SAFETY IS INVOLVED!



Safety is a primary concern in the design and manufacture of our products. Unfortunately, our efforts to provide safe equipment can be wiped out by a single careless act of an operator.

In addition to the design and configuration of equipment, hazard control and accident prevention are dependent upon the awareness, concern, prudence and proper training of personnel involved in the operation, transport, maintenance and storage of equipment.

It has been said "*The best safety device is an informed, careful operator.*" We ask you to be that kind of operator.

### INSTALLATION

- Hydraulics must only be connected as instructed in this manual. Do not substitute parts, modify, or connect in any other way.
- After connecting hoses, check that all control lever positions function as instructed in the Operator's Manual. Do not operate until control lever and equipment movements are correct.

### TRAINING

- Safety instructions are important! Read all attachment and power unit manuals; follow all safety rules and safety decal information. (Replacement manuals are available from dealer or, in the United States and Canada, call 1-712-859-3293.) Failure to follow instructions or safety rules can result in serious injury or death.
- If you do not understand any part of this manual and need assistance, see your dealer.
- Know your controls and how to stop engine and attachment quickly in an emergency.
- Operators must be instructed in and be capable of the safe operation of the equipment, its attachments and all controls. Do not allow anyone to operate this equipment without proper instructions.
- Keep hands and body away from pressurized lines. Use paper or cardboard, not body parts to check for leaks. Wear safety goggles. Hydraulic fluid under pressure can easily penetrate skin and will cause serious injury or death.
- Make sure that all operating and service personnel know that in the event hydraulic fluid penetrates skin, it must be surgically removed as soon as possible by a doctor familiar with this form of injury, or gangrene, serious injury or death will result. CONTACT A

PHYSICIAN IMMEDIATELY IF FLUID ENTERS SKIN OR EYES. DO NOT DELAY.

- Do not allow children or untrained persons to operate equipment.

### PREPARATION

- Check that all hardware is tight and properly installed.
- Always check with your skid steer manual or dealer for counterweight ballast that may be required for machine stability.
- Air in hydraulic systems can cause erratic operation and allows loads or equipment components to drop unexpectedly. Before operating or allowing anyone to approach the equipment, purge any air in the system by operating all hydraulic functions several times after connecting equipment, connecting hoses, or doing any hydraulic maintenance.
- After connecting hoses, check that all control lever positions function as instructed in the Operator's Manual. Do not operate until control lever and equipment movements are correct.
- Make sure all hydraulic hoses, fittings and valves are in good condition and not leaking before starting power unit or using equipment. Check and route hoses carefully to prevent damage. Hoses must not be twisted, bent sharply, kinked, frayed, pinched, or come into contact with any moving parts. Operate moveable components through full operational range to check clearances. Replace any damaged hoses immediately.
- Always wear relatively tight and belted clothing to avoid entanglement in moving parts. Wear sturdy, rough-soled work shoes and protective equipment for eyes, hair, hands, hearing and head.
- Ensure implement is properly attached, adjusted and in good operating condition. Skid steer coupler lockpins must be fully extended and properly engaged into attachment retaining slots.
- Skid steer must be equipped with ROPS and seat belt/operator restraint. Keep seat belt/operator restraint securely fastened/engaged. Falling off skid steer can result in death from being run over or crushed. Keep ROPS systems in place at all times.

# OPERATION

Safety is a primary concern in the design and manufacture of our products. Unfortunately, our efforts to provide safe equipment can be wiped out by a single careless act of an operator.

In addition to the design and configuration of equipment, hazard control and accident prevention are dependent upon the awareness, concern, prudence and proper training of personnel involved in the operation, transport, maintenance and storage of equipment.

It has been said *"The best safety device is an informed, careful operator."* We ask you to be that kind of operator.

The operator is responsible for the safe operation of this equipment. Operators must be instructed in and be capable of the safe operation of the equipment, its attachments and all controls. Do not allow anyone to operate this equipment without proper instructions.

## WARNING

- **Safety instructions are important! Read all attachment and power unit manuals; follow all safety rules and safety decal information. (Replacement manuals are available from dealer or, in the United States and Canada, call 1-712-859-3293.) Failure to follow instructions or safety rules can result in serious injury or death.**
- **Do not allow children or untrained persons to operate equipment.**
- **Skid steer must be equipped with ROPS and seat belt/operator restraint. Keep seat belt/operator restraint securely fastened/engaged. Falling off skid steer can result in death from being run over or crushed. Keep ROPS systems in place at all times.**
- **Do not allow other people in the area when operating, attaching, removing, assembling or servicing equipment.**
- **Before leaving operator's seat, follow power unit manual instructions. Lower lift arms and put attachment on the ground. Stop engine, remove key, engage brake, and remove seat belt/operator restraint.**

Read the skid steer operator's manual for instructions on proper skid steer operation and safety.

Post hole diggers are designed for one-man operation. You must always dig holes while sitting in the skid steer seat. Never operate the digger with anyone near, or in contact with, any part of the

attachment, skid steer, or auger. Accidents have occurred when more than one person is in the immediate area of the operating equipment. Be sure no one else, including bystanders, is near when you operate this product.

## ATTACHING POST HOLE DIGGER TO SKID STEER WITH STANDARD UNIVERSAL BRACKET

### WARNING

- **Ensure implement is properly attached, adjusted and in good operating condition. Skid steer coupler lockpins must be fully extended and properly engaged into attachment retaining slots.**

Read the skid steer operator's manual connecting and removing instructions.

Position hydraulic hoses so they will not be pinched when connecting the attachment.

The skid steer coupler handles should be in the unlocked position and the lockpins retracted.

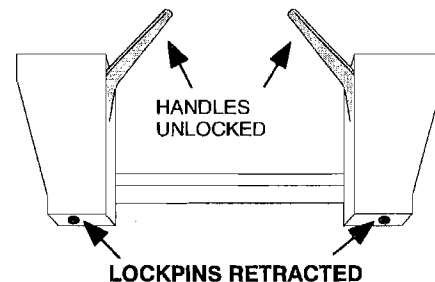

Skid Steer Coupler Handles - Unlocked

Move to the skid steer operator seat, fasten seat belt, engage operator restraint, and start engine.

Lower skid steer lift arms to their lowest position.

Carefully move and align the skid steer coupler to the post hole digger. The top of the skid steer coupler must index into the post hole digger flange.

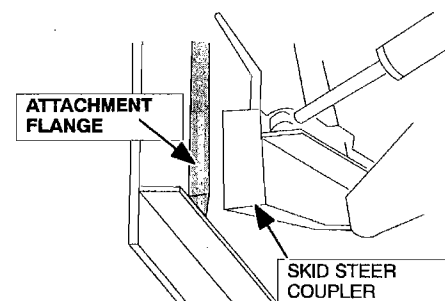

Attaching Post Hole Digger to Skid Steer

Roll the skid steer coupler into the post hole digger flange so the coupler handles can be engaged.

Shut off the engine, set brake, remove key, remove seat belt, and release operator restraint. Dismount the skid steer.

Move the skid steer coupler handles to the locked position. The lockpins must be completely extended and secured into the retaining slots provided on the post hole digger.

Connect hydraulic hoses to skid steer auxiliary quick couplers.

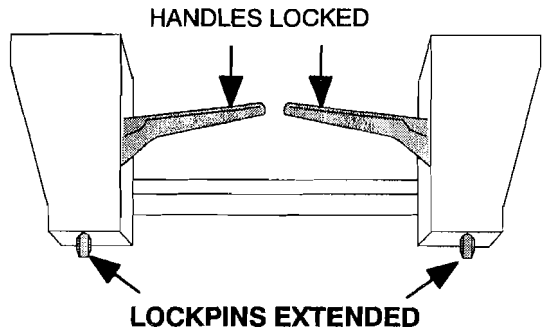

Skid Steer Coupler Handles - Locked

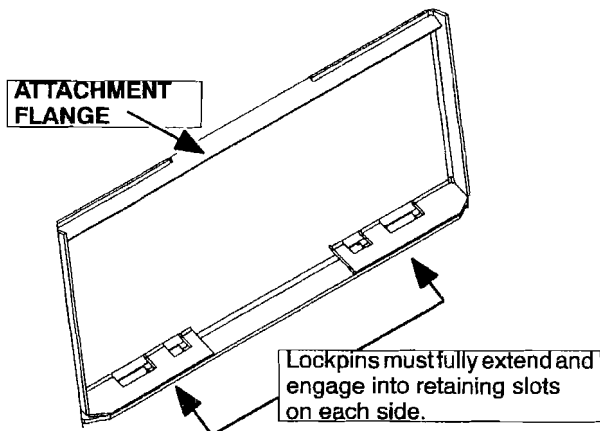

Retaining Slot Locations -  
Back View of Attachment

Other brackets use pins, chains and miscellaneous hooking devices. See their operator manual for proper locking.

**PRE-OPERATION CHECKLIST  
(OWNER'S RESPONSIBILITY)**

- \_\_\_ Review and follow all safety rules and safety decal instructions.
- \_\_\_ Check that all safety decals are installed and in good condition. Replace if damaged.
- \_\_\_ Check that all shields and guards are properly installed and in good condition. Replace if damaged.
- \_\_\_ Check that all hardware and cotter pins are properly installed and secured.
- \_\_\_ Check that auger point and all cutting edges are intact and in good repair.

- \_\_\_ Check that equipment is properly and securely attached to skid steer.
- \_\_\_ Consult local utilities before digging. Know location of and avoid contacting all underground cables, pipelines, overhead wires and other hazards in digging area.
- \_\_\_ Do not allow riders.
- \_\_\_ Check and keep all bystanders away from equipment working area.
- \_\_\_ Check all lubrication points and grease as instructed in "Service, lubrication information."
- \_\_\_ Check that all hydraulic hoses and fittings are in good condition and not leaking before starting skid steer. Check that hoses are not twisted, bent sharply, kinked, frayed or pulled tight. Replace any damaged hoses immediately.
- \_\_\_ Make sure skid steer ROPS and seat belt/operator restraint are in good condition. Keep seat belt/operator securely fastened during operation.

**OPERATING POST HOLE DIGGER**



- **Improper operation can cause the machine to tip or roll over and cause injury or death.**
  - Keep skid steer lift arms and attachment as low as possible.
  - Do not travel or turn with skid steer lift arms and attachment raised.
  - Turn on level ground.
  - Go up and down slopes, not across them.
  - Keep the heavy end of the machine uphill.
  - Do not overload the machine.
- **Look down and to the rear and make sure area is clear before operating in reverse.**

Move skid steer to the desired digging location.

Raise skid steer loader arms and rotate the attachment coupler fully forward until the auger is hanging vertically.

Position auger over the hole location. Auger should be about 4" to the front of the plumb line of the center of the top of the auger.

Place skid steer travel control levers in neutral position and set park brake. If the skid steer moves, the auger may be bent.

With the skid steer engine at idle position, engage skid steer auxiliary hydraulic control to start the auger.

Auger must turn clockwise for digging. If auger rotation is not correct, reverse skid steer auxiliary hydraulic flow.



Slowly lower the auger into the ground. Run the auger as slow as possible to keep it under control.

Increase skid steer engine speed slightly so that soil is conveyed from the hole.

Dig the hole in small steps. Dig down several inches, then bring auger up to let the soil clear. Repeat this procedure several times until the desired depth is reached. This procedure allows better control of the auger.

Do not force the auger into the ground using loader down pressure. In some soil types the auger may screw itself into the ground. Allow auger to dig its way into the soil and cycle the auger up and down. This will clear soil and prevent the auger from becoming stuck.

When the auger has reached the desired depth, leave auger at this depth for a short period to assist in cleaning loose dirt from the hole.

Stop auger and lower it to the storage position when not digging. Never exit the skid steer or allow anyone to approach the skid steer with the loader arms raised.

### LODGED AUGERS

If the auger gets stuck in wet clay, stones, or roots, disengage the drive motor immediately. Using the skid steer auxiliary hydraulic system, reverse the post hole digger drive motor. The auger should screw itself out of the ground and away from the obstruction.

### TRANSPORTING

When transporting the post hole digger, the skid steer lift arms must be fully lowered with the coupler rotated to the rear.

Rotate the skid steer coupler forward to rest the post hole auger on the ground when exiting the skid steer.

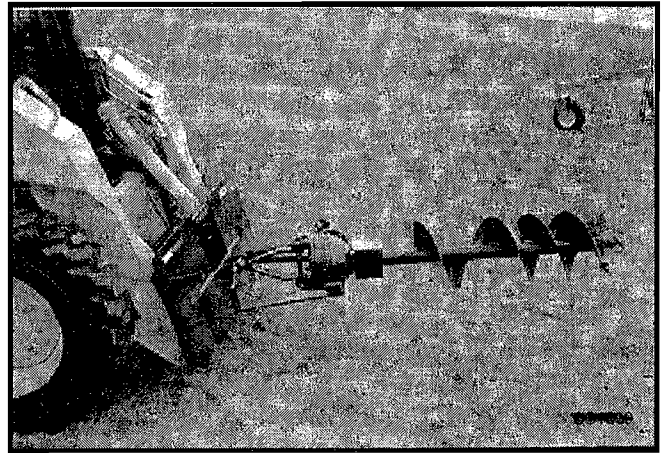

Never exit the skid steer or allow anyone to approach the skid steer with the loader arms raised.

### REMOVING FROM SKID STEER

On a hard level surface, lower attachment to the ground.

Shut off engine, set brake, remove key, remove seat belt and release operator restraint before leaving the skid steer operator's seat.

Move skid steer coupler handles to the unlocked position. Lockpins must be disengaged from attachment retaining slots.

Disconnect hydraulic hoses from quick couplers. Install dust plugs and coupler hoses together for storage.

Move to the skid steer operator seat, fasten seat belt, engage operator restraint, and start engine.

Release brake and roll skid steer coupler until it is disengaged from the attachment. The attachment should be placed in storage position.

### STORAGE

Inspect the post hole digger thoroughly and prepare for storage. Repair or replace any damaged components.

To store properly, the post hole digger must rest horizontally on the adapter plate and auger flights.

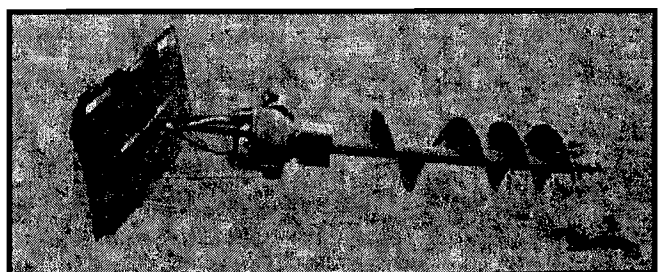



# OWNER SERVICE

The information in this section is written for operators who possess basic mechanical skills. Should you need help, your dealer has trained service technicians available. For your protection, read and follow all safety information in this manual.

## WARNING

- Safety instructions are important! Read all attachment and power unit manuals; follow all safety rules and safety decal information. (Replacement manuals are available from dealer or, in the United States and Canada, call 1-712-859-3293.) Failure to follow instructions or safety rules can result in serious injury or death.

## CAUTION

- If you do not understand any part of this manual and need assistance, see your dealer.
- Always wear relatively tight and belted clothing to avoid entanglement in moving parts. Wear sturdy, rough-soled work shoes and protective equipment for eyes, hair, hands, hearing and head.
- Tighten all bolts, nuts and screws to torque chart specifications. Check that all cotter pins are installed securely to ensure equipment is in a safe condition before operating.

## WARNING

- Ensure shields and guards are properly installed and in good condition. Replace if damaged.
- Never go underneath equipment lowered to the ground or raised. Never place any part of the body underneath equipment or between movable parts even when the engine has been turned off. Hydraulic system leak down,

hydraulic system failures, mechanical failures or movement of control levers can cause equipment to drop or rotate unexpectedly and cause severe injury or death.

- Service work does not require going underneath.
- Read operator's manual for service instructions or have done by a qualified dealer.

## WARNING

- Before leaving operator's seat, follow power unit manual instructions. Lower lift arms and put attachment on the ground. Stop engine, remove key, engage brake, and remove seat belt/operator restraint.
- Keep all persons away from operator control are while performing adjustments, service or maintenance.
- Do not disconnect hydraulic lines until machine is securely blocked or placed in lowest position and system pressure is released by operating valve levers.

## LUBRICATION

The digger gearbox is NOT filled at the factory. Fill with SAE 90W gear oil and check periodically to maintain correct oil level.

After the first 50 hours and every 250 hours thereafter, it is recommended that the gearbox be drained, flushed and refilled with SAE 90W.

| GEAR OIL CAPACITY |        |
|-------------------|--------|
| MODEL             | QUARTS |
| 510 or 1020       | 2      |

## NOTES

# HYDRAULIC DIGGER PARTS BREAKDOWN

| Illus. # | Part Number             | Description   |
|----------|-------------------------|---|
| 1.       | SD-069                  | Output Shaft Shield                                       |
| 2.       | SA-1051                 | Pin w/ Cotter Pins  |
| 3.       | SA-61402                | Pin w/ Cotter Pins  |
| 4.       | SD-510-17               | Gearbox/Motor Assembly                                    |
| 5.       | SD-510-751              | Stabilizing Spring  |
| 6.       | SD-510-76               | Stabilizing Spring Bracket                                |
| 7.       | SD-510-83               | Swivel Fitting  |
| 8.       | SA-304                  | Auger Tube Nut  |
| 9.       | SA-303                  | Auger Tube Lockwasher                                     |
| 10.      | SA-62001                | Auger Tube Bolt   |
| 11.      | SA-304-P                | Auger Point   |
| 12.      | SA-6230                 | Auger Teeth   |
| 13.      | SA-62301<br>SA-62302    | Bolt<br>Nut   |
| 14.      | SD-510-8                | Digger Mount  |
| 15.      | SD-0607-510             | Gearbox w/ mount  |
| 16.      | SD-1020-7<br>SD-1020-72 | Hydraulic Motor (5-10 GPM)<br>Hydraulic Motor (10-20 GPM) |
| 17.      | SD-510-71               | Motor Mount Only  |

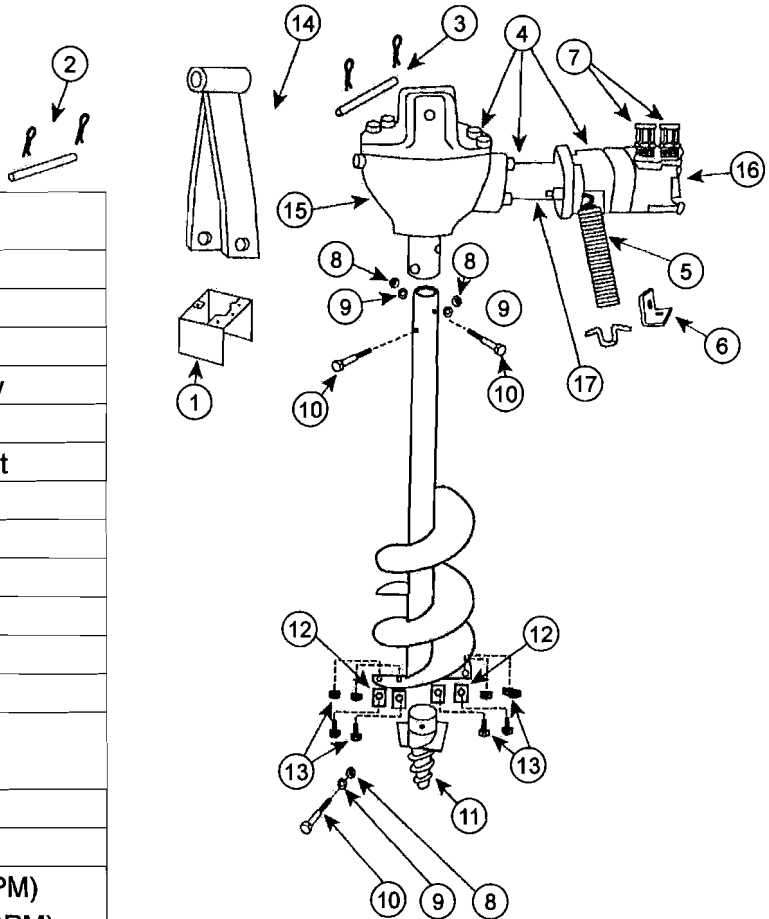

## SD-0607 GEARBOX PARTS LIST

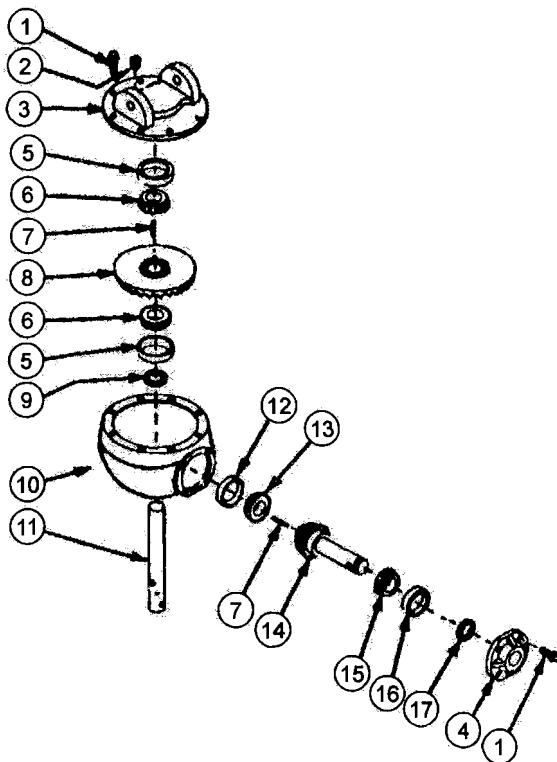

| Illus. # | Part Number | Description           |
|----------|-------------|-----------------------|
| 1.       | SD-BT0601   | Bolt (10 Reg.)        |
| 2.       | SD-060716   | Pipe Plug 1/2" NPT    |
| 3.       | SD-060701   | Cover                 |
| 4.       | SD-060703   | Input Bearing Housing |
| 5.       | SD-060708   | Bearing Cone (2 Reg.) |
| 6.       | SD-060707   | Bearing Cup (2 Reg.)  |
| 7.       | SD-060715   | Key Woodruff          |
| 8.       | SD-060705   | Bevel Gear 35T        |
| 9.       | SD-060713   | Seal Output           |
| 10.      | SD-060702   | Gear Case             |
| 11.      | SD-060706   | Output Shaft          |
| 12.      | SD-060712   | Bearing Cone (Input)  |
| 13.      | SD-060711   | Bearing Cup (Input)   |
| 14.      | SD-060704   | Pinion Gear & Shaft   |
| 15.      | SD-060710   | Bearing Cone (Input)  |
| 16.      | SD-060709   | Bearing Cup (Input)   |
| 17.      | SD-060714   | Seal Input            |



# FOR YOUR RECORDS

*Making hard work easy*

**Shaver Manufacturing Company**  
*Setting the standard in fencing and landscape equipment*

P.O. Box 358, Graettinger, IA 51342  
712-859-3293 • FAX 712-859-3294

Date Purchased: \_\_\_\_\_ Serial #: \_\_\_\_\_

\*Where Purchased: \_\_\_\_\_ Invoice #: \_\_\_\_\_

***Please Return Card to Assure Warranty***

Warranty on your 510/1020 is one year from date of purchase. The gearbox features a 5 year limited warranty. Should you have any problems, file a claim with your dealer.\*



*Making hard work easy*

**Shaver Manufacturing Company**  
*Setting the standard in fencing and landscape equipment*

P.O. Box 358, Graettinger, IA 51342 • 712-859-3293 • FAX 712-859-3294

© April 2002