

# FERRI®







[www.ferri-america.com](http://www.ferri-america.com)



## ZME

### **Offset/in-line slope mowers**

*Specifically designed for compact tractors*

<b>ZME 125</b>		18 to 30 HP		4'1"		5'9"
<b>ZME 155</b>		25 to 40 HP		5'1"		6'8"





# Offset/in-line slope mowers

Specifically designed for compact tractors

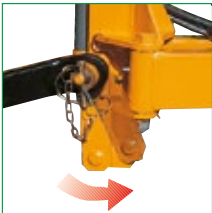

ZME is specifically designed for compact tractors; and is one-of-a-kind, it is ideally suited for tractors over 1555 lbs.

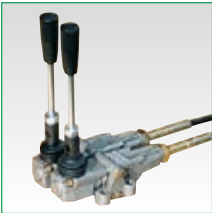
Equipment	ZME 125	ZME 150
Stiffening plate to stabilize unit	●	●
 Rotation joint on self lubricating bushing.	●	●
 Mechanical breakaway	●	●
Front and rear guard	●	●
Rear adjustable roller	●	●
 Rotor with internal sealed bearings	●	●
PTO shaft with overrun clutch	●	●
 Cable controls with floating head	□	□

● Standard    □ Optional

Tractors (recommended features)	Min. weight	Min. width
HP Tractor	10    20    30    40	lbs    ft
ZME 125	1555*	3' 7"
ZME 155	2000*	3' 11"

\* = verify possible need for ballast

## Work positions

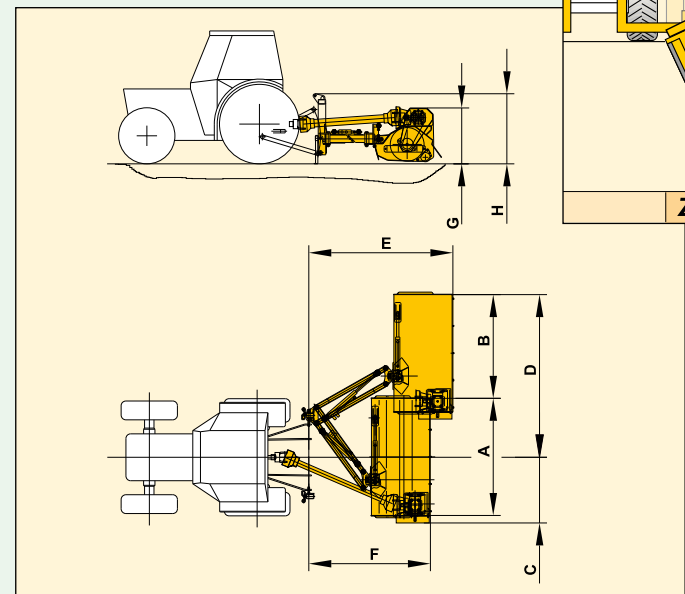

	ZME 125	ZME 155
A	m 4'1"	m 5'1"
B	m 3'8"	m 3'8"
C	m 2'4"	m 2'4"
D	m 5'9"	m 6'8"
E	m 5'1"	m 5'1"
F	m 4'3"	m 4'3"
G	m 1'12"	m 1'12"
H	m 2'6"	m 2'6"

## Technical specifications

Model	ZME125	ZME155
Width of cut	ft 4'1"	ft 5'1"
Flail head angle	+90°/-50°	+90°/-50°
Belts (SPAX type )	No. 3	No. 3
Blade tip speed	ft/sec 150	ft/sec 150
Weight	lbs 511	lbs 575
Three point linkage	Cat. I	Cat. I
PTO speed	RPM 540	RPM 540
 Articulated "Y" flails max cut 1"	No. 56	No. 72



**FERRI srl**  
Via Govoni, 30 - 44034 Tamara (FE) Italy  
Tel. +39 0532 866866 - Fax +39 0532 866851  
info@ferrisrl.it - www.ferrisrl.it



**North America Sales and Marketing Manager / FERRI**  
Ronald E. Roglis  
Glenarm, Illinois 62536  
Cell (314) 422-9460  
Fax (217) 483-4123  
E-mail: ron.roglis@gmail.com

**Parts Stock / FERRI:**  
J.S. Woodhouse Co., Inc.  
1314 Union Street - P.O. Box 1169  
West Springfield, Ma. 01090 U.S.A.  
tel. 413-736-5462  
fax 413-732-3786  
info@jswoodhouse.com

All data subject to change    campbelladv.com 77314    ZME - USA - EN    Rev.10 - 500